



POWER SUPPLY

- AC 100-240V Wide-range Input
- Width only 60mm
- Efficiency up to 93.5%
- 150% (360W) Peak Load Capability
- Easy Fuse Tripping due to High Overload Current
- Active Power Factor Correction (PFC)
- Negligible low Inrush Current Surge
- Short-term Operation down to 60Vac and up to 300Vac
- Full Power Between -25°C and +60°C
- DC-OK Relay Contact
- Quick-connect Spring-clamp Terminals
- 3 Year Warranty

GENERAL DESCRIPTION

The most outstanding features of this Dimension Q-Series DIN-rail power supply are the high efficiency and the small size, which are achieved by a synchronous rectification and further novel design details. The Q-Series is part of the Dimension family, existing alongside the lower featured C-Series.

With short-term peak power capability of 150% and built-in large sized output capacitors, these features help start motors, charge capacitors and absorb reverse energy and often allow a unit of a lower wattage class to be used.

High immunity to transients and power surges as well as low electromagnetic emission makes usage in nearly every environment possible.

The integrated output power manager, a wide range input voltage design and virtually no input inrush current make installation and usage simple. Diagnostics are easy due to the dry DC-ok contact, a green DC-ok LED and red overload LED.

Unique quick-connect spring-clamp terminals allow a safe and fast installation and a large international approval package for a variety of applications makes this unit suitable for nearly every situation.

SHORT-FORM DATA

| | | |
|-------------------|------------------|-----------------|
| Output voltage | DC 24V | |
| Adjustment range | 24 - 28V | |
| Output current | 10 - 9A | continuous |
| | 15 - 13.5A | for typ. 4s |
| Output power | 240W | continuous |
| | 360W | for typ. 4s |
| Output ripple | < 50mVpp | 20Hz to 20MHz |
| Input voltage | AC 100-240V | ±15% |
| Mains frequency | 50-60Hz | ±6% |
| AC Input current | 2.22 / 1.22A | at 120 / 230Vac |
| Power factor | 0.98 / 0.92 | at 120 / 230Vac |
| AC Inrush current | typ. 4 / 7A peak | at 120 / 230Vac |
| Efficiency | 92.6 / 93.5% | at 120 / 230Vac |
| Losses | 19.1 / 16.7W | at 120 / 230Vac |
| Temperature range | -25°C to +70°C | operational |
| Derating | 6W/°C | +60 to +70°C |
| Hold-up time | typ. 27 / 28ms | at 120 / 230Vac |
| Dimensions | 60x124x117mm | WxHxD |

ORDER NUMBERS

| | | |
|--------------|--------------------|-----------------------|
| Power Supply | QS10.241 | 24-28V Standard unit |
| | QS10.241-A1 | ATEX approved unit |
| | QS10.241-C1 | Conformal coated unit |
| | QS10.241-D1 | Extended DC-Input |
| Accessory | ZM1.WALL | Wall mount bracket |
| | ZM13.SIDE | Side mount bracket |
| | YR2.DIODE | Redundancy module |
| | UF20.241 | Buffer module |

MARKINGS



INDEX

| | Page | | Page |
|---|------|---|------|
| 1. Intended Use | 3 | 21.1. ZM1.WALL Wall Mounting Bracket | 20 |
| 2. Installation Requirements..... | 3 | 21.2. ZM13.SIDE Side Mounting Bracket | 20 |
| 3. AC-Input..... | 4 | 21.3. UF20.241 Buffer Module | 21 |
| 4. DC-Input..... | 5 | 21.4. YR2.DIODE Redundancy Module | 21 |
| 5. Input Inrush Current | 6 | 22. Application Notes..... | 22 |
| 6. Output | 7 | 22.1. Repetitive Pulse Loading | 22 |
| 7. Hold-up Time..... | 9 | 22.2. Peak Current Capability | 23 |
| 8. DC-OK Relay Contact | 9 | 22.3. Back-feeding Loads | 23 |
| 9. Efficiency and Power Losses..... | 10 | 22.4. External Input Protection..... | 23 |
| 10. Reliability | 11 | 22.5. Charging of Batteries | 24 |
| 11. Functional Diagram..... | 12 | 22.6. Output Circuit Breakers..... | 24 |
| 12. Terminals and Wiring..... | 12 | 22.7. Parallel Use to Increase Output Power | 25 |
| 13. Front Side and User Elements..... | 13 | 22.8. Parallel Use for Redundancy | 25 |
| 14. EMC..... | 14 | 22.9. Daisy Chaining of Outputs | 26 |
| 15. Environment | 15 | 22.10. Series Operation | 26 |
| 16. Protection Features | 16 | 22.11. Inductive and Capacitive Loads..... | 26 |
| 17. Safety Features | 16 | 22.12. Operation on Two Phases | 27 |
| 18. Dielectric Strength | 17 | 22.13. Use in a Tightly Sealed Enclosure | 27 |
| 19. Approvals..... | 18 | 22.14. Mounting Orientations | 28 |
| 20. Physical Dimensions and Weight..... | 19 | | |
| 21. Accessories..... | 20 | | |

The information presented in this document is believed to be accurate and reliable and may change without notice. No part of this document may be reproduced or utilized in any form without permission in writing from the publisher.

TERMINOLOGY AND ABBREVIATIONS

| | |
|--|---|
| PE and \oplus symbol | PE is the abbreviation for Protective Earth and has the same meaning as the symbol \oplus . |
| Earth, Ground | This document uses the term "earth" which is the same as the U.S. term "ground". |
| T.b.d. | To be defined, value or description will follow later. |
| AC 230V | A figure displayed with the AC or DC before the value represents a nominal voltage with standard tolerances (usually $\pm 15\%$) included. E.g.: DC 12V describes a 12V battery disregarding whether it is full (13.7V) or flat (10V) |
| 230Vac | A figure with the unit (Vac) at the end is a momentary figure without any additional tolerances included. |
| 50Hz vs. 60Hz | As long as not otherwise stated, AC 230V parameters are valid at 50Hz mains frequency. |
| may | A key word indicating flexibility of choice with no implied preference. |
| shall | A key word indicating a mandatory requirement. |
| should | A key word indicating flexibility of choice with a strongly preferred implementation. |

1. INTENDED USE

This device is designed for installation in an enclosure and is intended for the general use such as in industrial control, office, communication, and instrumentation equipment.

Do not use this power supply in aircraft, trains, nuclear equipment or similar systems where malfunction may cause severe personal injury or threaten human life.

This device is designed for use in hazardous, non-hazardous, ordinary or unclassified locations.

2. INSTALLATION REQUIREMENTS

This device may only be installed and put into operation by qualified personnel.

This device does not contain serviceable parts. The tripping of an internal fuse is caused by an internal defect.

If damage or malfunction should occur during installation or operation, immediately turn power off and send unit to the factory for inspection.

Mount the unit on a DIN-rail so that the output terminals are located on the top and the input terminals are located on the bottom of the unit. For other mounting orientations see de-rating requirements in this document. See chapter 22.14.

This device is designed for convection cooling and does not require an external fan. Do not obstruct airflow and do not cover ventilation grid (e.g. cable conduits) by more than 30%!

Keep the following installation clearances: 40mm on top, 20mm on the bottom, 5mm on the left and right sides are recommended when the device is loaded permanently with more than 50% of the rated power. Increase this clearance to 15mm in case the adjacent device is a heat source (e.g. another power supply).

 **WARNING** Risk of electrical shock, fire, personal injury or death.

- Do not use the power supply without proper grounding (Protective Earth). Use the terminal on the input block for earth connection and not one of the screws on the housing.
- Turn power off before working on the device. Protect against inadvertent re-powering.
- Make sure that the wiring is correct by following all local and national codes.
- Do not modify or repair the unit.
- Do not open the unit as high voltages are present inside.
- Use caution to prevent any foreign objects from entering the housing.
- Do not use in wet locations or in areas where moisture or condensation can be expected.
- Do not touch during power-on, and immediately after power-off. Hot surfaces may cause burns.

3. AC-INPUT

| | | | |
|---------------------------|--------------------------------------|-------------|---|
| AC input | nom. | AC 100-240V | suitable for TN-, TT- and IT mains networks |
| AC input range | min. | 85-276Vac | continuous operation |
| | min. | 60-85Vac | full power for 200ms, no damage between 0 and 85Vac |
| | min. | 276-300Vac | < 500ms |
| | max. | 276Vac | continuous, IEC 62103 |
| Input frequency | nom. | 50-60Hz | ±6% |
| Turn-on voltage | typ. | 81Vac | steady-state value, see Fig. 3-1 |
| Shut-down voltage | typ. | 63Vac | steady-state value, see Fig. 3-1 |
| | typ. | 55Vac | dynamic value |
| External input protection | See recommendations in chapter 22.4. | | |

| | | AC 100V | AC 120V | AC 230V | |
|-------------------|------|---------|---------|---------|------------------------------|
| Input current | typ. | 2.65A | 2.22A | 1.22A | at 24V, 10A, see Fig. 3-3 |
| Power factor *) | typ. | 0.99 | 0.98 | 0.92 | at 24V, 10A, see Fig. 3-4 |
| Crest factor **) | typ. | 1.65 | 1.67 | 1.85 | at 24V, 10A |
| Start-up delay | typ. | 800ms | 650ms | 340ms | see Fig. 3-2 |
| Rise time | typ. | 8ms | 8ms | 8ms | 0mF, 24V, 10A, see Fig. 3-2 |
| | typ. | 15ms | 15ms | 15ms | 10mF, 24V, 10A, see Fig. 3-2 |
| Turn-on overshoot | max. | 100mV | 100mV | 100mV | see Fig. 3-2 |

*) The power factor is the ratio of the true (or real) power to the apparent power in an AC circuit.

***) The crest factor is the mathematical ratio of the peak value to RMS value of the input current waveform.

Fig. 3-1 Input voltage range

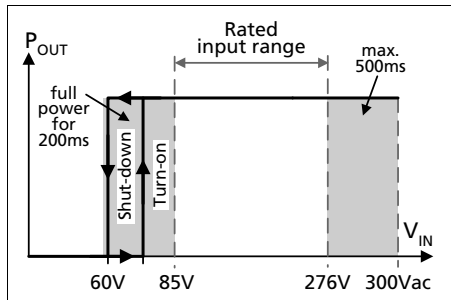

Fig. 3-2 Turn-on behavior, definitions

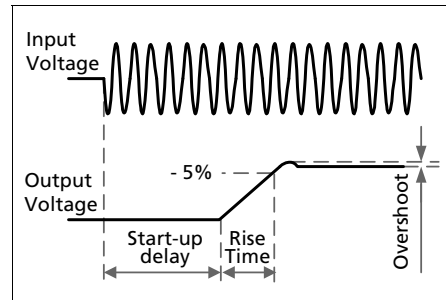

Fig. 3-3 Input current vs. output load at 24V

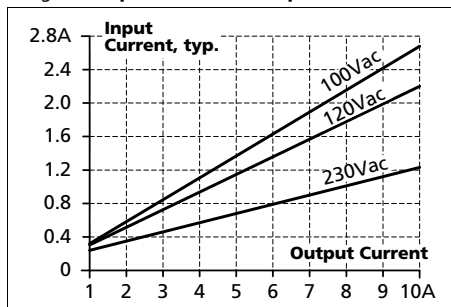
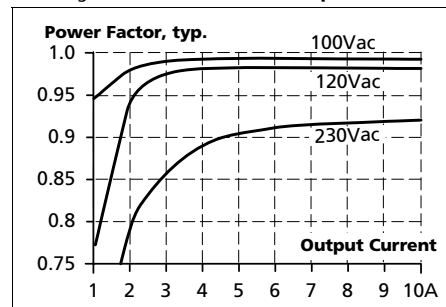

Fig. 3-4 Power factor vs. output load



4. DC-INPUT

QS10.241, QS10.241-A1, QS10.241-C1:

| | | | |
|------------------|------|-------------|----------------------|
| DC input | nom. | DC 110-150V | -20%/+25% |
| DC input range | min. | 88-187Vdc | continuous operation |
| DC input current | typ. | 2.37A | 110Vdc, at 24V, 10A |

QS10.241-D1:

| | | | |
|------------------|------|-------------|-------------------------|
| DC input | nom. | DC 110-300V | -20%/+25% |
| DC input range | min. | 88-375Vdc | continuous operation |
| DC input current | typ. | 2.37/ 0.85A | 110/300Vdc, at 24V, 10A |

All units:

| | | | |
|------------------------------|------|--------|-----------------------|
| Allowed Voltage L/N to Earth | max. | 375Vdc | continuous, IEC 62103 |
| Turn-on voltage | typ. | 80Vdc | steady state value |
| Shut-down voltage | typ. | 55Vdc | steady state value |

Fig. 4-1 Wiring for DC Input

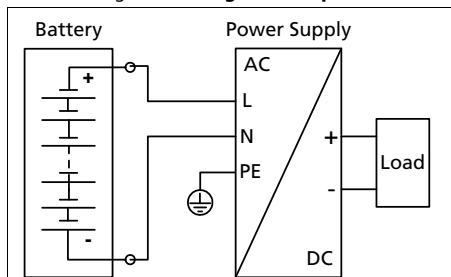

Instructions for DC use:

- Use a battery or similar DC source.
For other sources contact PULS
- Connect +pole to L and -pole to N.
- Connect the PE terminal to a earth wire or to the machine ground.
- A supply from the intermediate DC-bus of a frequency converter is not recommended and can cause a malfunction or damage the unit.

5. INPUT INRUSH CURRENT

An active inrush limitation circuit limits the input inrush current after turn-on of the input voltage and after short input voltage interruptions.

The charging current into EMI suppression capacitors is disregarded in the first microseconds after switch-on.

| | | AC 100V | AC 120V | AC 230V | |
|------------------|------|---------------------|---------------------|---------------------|-------------------------------|
| Inrush current | max. | 10A _{peak} | 10A _{peak} | 10A _{peak} | over entire temperature range |
| | typ. | 5A _{peak} | 4A _{peak} | 7A _{peak} | over entire temperature range |
| Inrush energy | max. | 4A ² s | 4A ² s | 4A ² s | over entire temperature range |
| Inrush delay (A) | typ. | 650ms | 520ms | 250ms | see (A) in Fig. 5-1 |

Fig. 5-1 Input inrush current, typical behavior

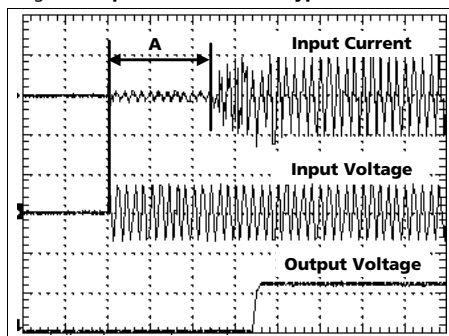

A.... Inrush delay

Input: 230Vac
 Output: 24V, 10A
 Ambient: 25°C
 Upper curve: Input current 2A / DIV
 Middle curve: Input voltage 500V / DIV
 Lower curve: Output voltage 20V / DIV
 Time basis: 100ms / DIV

6. OUTPUT

| | | | |
|---------------------------|---------------|----------------|---|
| Output voltage | nom. | 24V | |
| Adjustment range | min. | 24-28V | guaranteed |
| | max. | 30V ***) | at clockwise end position of potentiometer |
| Factory setting | typ. | 24.1V | ±0.2%, at full load, cold unit |
| Line regulation | max. | 10mV | 60-300Vac |
| Load regulation | max. | 100mV | static value, 0A → 10A |
| Ripple and noise voltage | max. | 50mVpp | 20Hz to 20MHz, 50Ohm |
| Output current | nom. | 10A | continuously available at 24V, see Fig. 6-1 |
| | nom. | 9A | continuously available at 28V, see Fig. 6-1 |
| | nom. | 15A *) | short term available BonusPower® *) at 24V, for typical 4s, see Fig. 6-1 |
| | nom. | 13.5A *) | short term available BonusPower® *) at 28V, for typical 4s, see Fig. 6-1 |
| Output power | nom. | 240W / 252W | continuously available at 24V / 28V |
| | nom. | 360W / 378W *) | short term available BonusPower® *) at 24V / 28V |
| BonusPower® time | typ. | 4s | duration until the output voltage dips, see Fig. 6-2 |
| | min. | 3s | |
| | max. | 5s | |
| BonusPower® recovery time | typ. | 7s | overload free time to reset power manager, see Fig. 6-3 |
| Overload behaviour | cont. current | | |
| Short-circuit current | min. | 8A **) | continuous, load impedance 100mOhm, see Fig. 6-1 |
| | max. | 12.5A **) | continuous, load impedance 100mOhm, see Fig. 6-1 |
| | min. | 21A **) | during BonusPower® *) load impedance 100mOhm |
| | max. | 27A **) | during BonusPower® *) load impedance 100mOhm |
| | max. | 15A **) | continuous, load impedance <10mOhm, see Fig. 6-1 |
| Output capacitance | typ. | 7 000µF | included inside the power supply |

*) BonusPower®, short term power capability (up to typ. 4s)

The power supply is designed to support loads with a higher short-term power requirement without damage or shutdown. The short-term duration is hardware controlled by an output power manager. This BonusPower® is repeatedly available. Detailed information can be found in chapter 22.1. If the power supply is loaded longer with the BonusPower® than shown in the Bonus-time diagram (see Fig. 6-2), the max. output power is automatically reduced to 240/252W.

**) Discharge current of output capacitors is not included.

***) This is the maximum output voltage which can occur at the clockwise end position of the potentiometer due to tolerances. It is not guaranteed value which can be achieved. The typical value is about 28.6V.

Peak current capability (up to several milliseconds)

The power supply can deliver a peak current which is higher than the specified short term current. This helps to start current demanding loads or to safely operate subsequent circuit breakers.

The extra current is supplied by the output capacitors inside the power supply. During this event, the capacitors will be discharged and causes a voltage dip on the output. Detailed curves can be found in chapter 22.2.

| | | | |
|---------------------------|------|-------------------|---------------------------------|
| Peak current voltage dips | typ. | from 24V to 20.5V | at 20A for 50ms, resistive load |
| | typ. | from 24V to 18V | at 50A for 2ms, resistive load |
| | typ. | from 24V to 14V | at 50A for 5ms, resistive load |

Fig. 6-1 Output voltage vs. output current, typ.

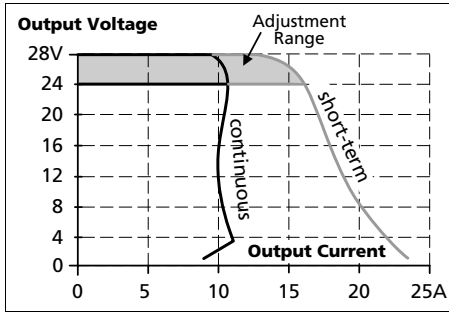

Fig. 6-2 Bonus time vs. output power

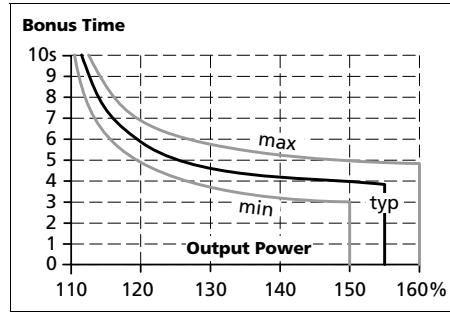
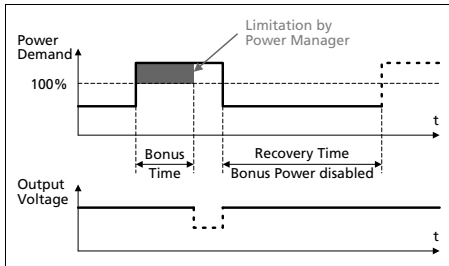

Fig. 6-3 BonusPower® recovery time



The BonusPower® is available as soon as power comes on and immediately after the end of an output short circuit or output overload.

Fig. 6-4 BonusPower® after input turn-on

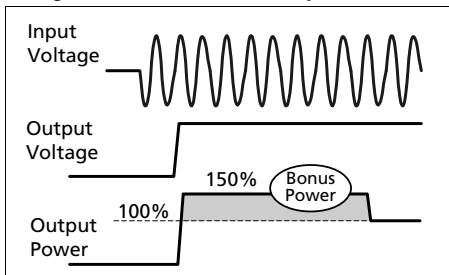
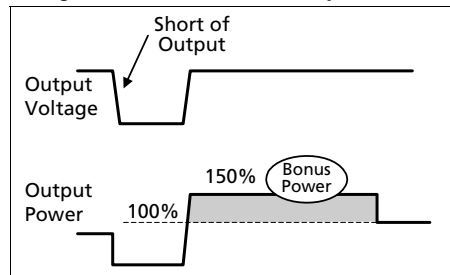

Fig. 6-5 BonusPower® after output short



7. HOLD-UP TIME

| | | AC 100V | AC 120V | AC 230V | |
|--------------|------|---------|---------|---------|---------------------------|
| Hold-up Time | typ. | 51ms | 53ms | 55ms | at 24V, 5A, see Fig. 7-1 |
| | typ. | 26ms | 27ms | 28ms | at 24V, 10A, see Fig. 7-1 |

Fig. 7-1 Hold-up time vs. input voltage

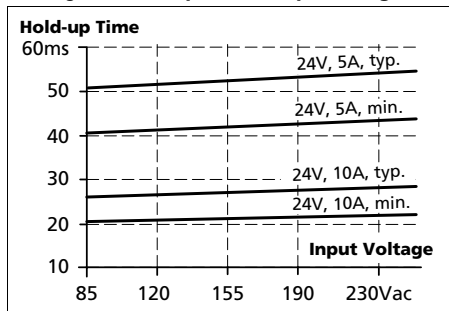
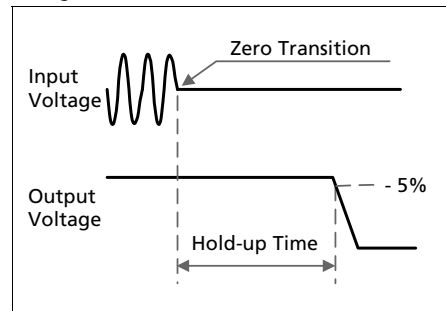

Fig. 7-2 Shut-down behavior, definitions



8. DC-OK RELAY CONTACT

This feature monitors the output voltage, which is produced by the power supply itself. It is independent of a back-fed voltage from a unit connected in parallel to the power supply output.

| | | | |
|-------------------|---|----------------------------------|-----------------------|
| Contact closes | As soon as the output voltage reaches the adjusted output voltage level. | | |
| Contact opens | As soon as the output voltage dips more than 10% below the adjusted output voltage. Short dips will be extended to a signal length of 250ms. Dips shorter than 1ms will be ignored. | | |
| Contact re-closes | As soon as the output voltage exceeds 90% of the adjusted voltage. | | |
| Contact ratings | max | 60Vdc 0.3A, 30Vdc 1A, 30Vac 0.5A | resistive load |
| | min | 1mA at 5Vdc | min. permissible load |
| Isolation voltage | See dielectric strength table in section 18. | | |

Fig. 8-1 DC-ok relay contact behavior

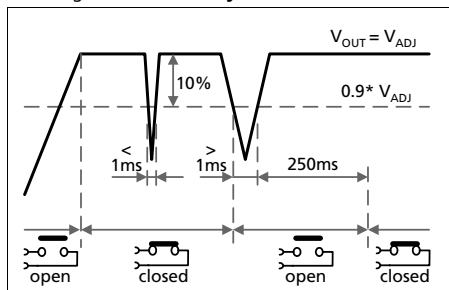

Note: The DC-ok feature requires that the output voltage reaches the nominal (=adjusted) level after turn-on in order to function according to specification. If this level cannot be achieved, the overload lamp will be on and the DC-ok contact will be open. The overload signal will only shut off as soon as the adjusted voltage is reached. This is an important condition to consider particularly, if the load is a battery, the power supply is used in parallel or the power supply is used for N+1 redundant systems.

9. EFFICIENCY AND POWER LOSSES

| | | AC 100V | AC 120V | AC 230V | |
|-----------------------|------|---------|---------|---------|---|
| Efficiency | typ. | 91.5% | 92.6% | 93.5% | at 24V, 10A |
| Average efficiency *) | typ. | 91.7% | 92.4% | 92.4% | 25% at 2.5A, 25% at 5A, 25% at 7.5A, 25% at 10A |
| Power losses | typ. | 4.4W | 4.9W | 6.1W | at 24V, 0A |
| | typ. | 22.4W | 19.1W | 16.7W | at 24V, 10A |

*) The average efficiency is an assumption for a typical application where the power supply is loaded with 25% of the nominal load for 25% of the time, 50% of the nominal load for another 25% of the time, 75% of the nominal load for another 25% of the time and with 100% of the nominal load for the rest of the time.

Fig. 9-1 Efficiency vs. output current at 24V, typ

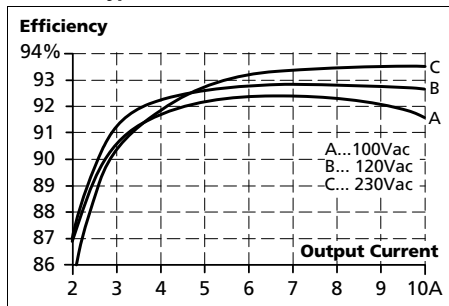

Fig. 9-2 Losses vs. output current at 24V, typ.

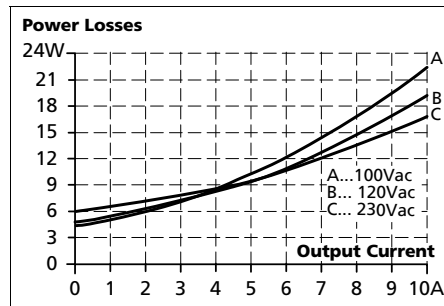

Fig. 9-3 Efficiency vs. input voltage at 24V, 10A, typ.

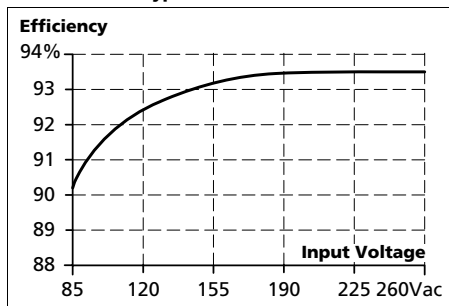
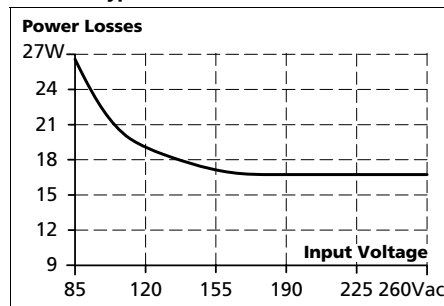

Fig. 9-4 Losses vs. input voltage at 24V, 10A, typ.



10. RELIABILITY

| | AC 100V | AC 120V | AC 230V | |
|------------------------------|------------|------------|------------|--|
| Lifetime expectancy *) | 58 000h | 68 000h | 71 000h | at 24V, 10A and 40°C |
| | 117 000h | 122 000h | 117 000h | at 24V, 5A and 40°C |
| | 165 000h*) | 192 000h*) | 200 000h*) | at 24V, 10A and 25°C |
| MTBF **) SN 29500, IEC 61709 | 478 000h | 535 000h | 581 000h | at 24V, 10A and 40°C |
| | 827 000h | 926 000h | 1 005 000h | at 24V, 10A and 25°C |
| MTBF **) MIL HDBK 217F | 334 000h | 341 000h | 345 000h | at 24V, 10A and 40°C; Ground Benign GB40 |
| | 460 000h | 469 000h | 474 000h | at 24V, 10A and 25°C; Ground Benign GB25 |

*) The **Lifetime expectancy** shown in the table indicates the minimum operating hours (service life) and is determined by the lifetime expectancy of the built-in electrolytic capacitors. Lifetime expectancy is specified in operational hours and is calculated according to the capacitor's manufacturer specification. The manufacturer of the electrolytic capacitors only guarantees a maximum life of up to 15 years (131 400h). Any number exceeding this value is a calculated theoretical lifetime which can be used to compare devices.

) **MTBF stands for **Mean Time Between Failure**, which is calculated according to statistical device failures, and indicates reliability of a device. It is the statistical representation of the likelihood of a unit to fail and does not necessarily represent the life of a product. The MTBF figure is a statistical representation of the likelihood of a device to fail. A MTBF figure of e.g. 1 000 000h means that statistically one unit will fail every 100 hours if 10 000 units are installed in the field. However, it can not be determined if the failed unit has been running for 50 000h or only for 100h.

11. FUNCTIONAL DIAGRAM

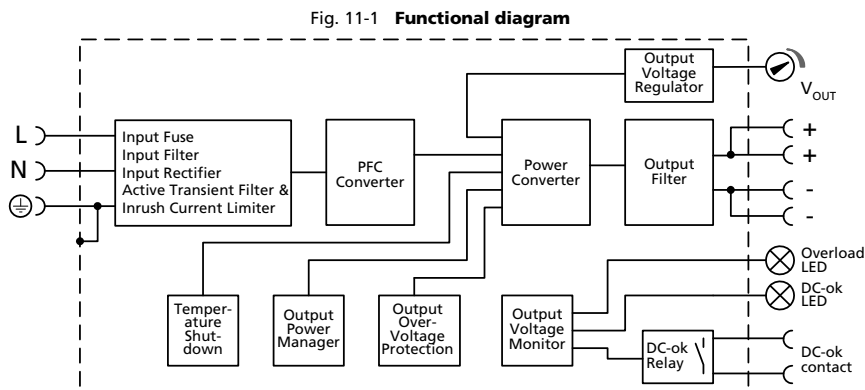

12. TERMINALS AND WIRING

Bi-stable, quick-connect spring clamp terminals. IP20 Finger safe construction. Suitable for field- and factory installation. Shipped in open position.

| | Input | Output | DC-OK-Signal |
|-------------------------------|--|------------------------|------------------------|
| Type | spring-clamp terminals | spring-clamp terminals | spring-clamp terminals |
| Solid wire | 0.5-6mm ² | 0.5-6mm ² | 0.5-6mm ² |
| Stranded wire | 0.5-4mm ² | 0.5-4mm ² | 0.5-4mm ² |
| American Wire Gauge | 20-10 AWG | 20-10 AWG | 20-10 AWG |
| Wire stripping length | 10mm / 0.4inch | 10mm / 0.4inch | 10mm / 0.4inch |
| Screwdriver | not applicable | not applicable | not applicable |
| Recommended tightening torque | not applicable | not applicable | not applicable |
| Pull-out force | 10AWG:80N, 12AWG:60N, 14AWG:50N, 16AWG:40N (according to UL486E) | | |

Instructions:

- a) Use appropriate copper cables that are designed for minimum operating temperatures of:
 - 60°C for ambient up to 45°C and
 - 75°C for ambient up to 60°C minimum
 - 90°C for ambient up to 70°C minimum.
- b) Follow national installation codes and installation regulations!
- c) Ensure that all strands of a stranded wire enter the terminal connection!
- d) Up to two stranded wires with the same cross section are permitted in one connection point (except PE wire).
- e) Do not use the unit without PE connection.
- f) Unused terminal compartments should be securely tightened.
- g) Ferrules are allowed.

Fig. 12-1 Connecting a wire

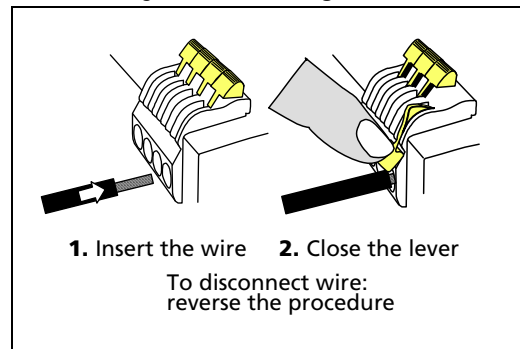

13. FRONT SIDE AND USER ELEMENTS

Fig. 13-1 Front side



A Input Terminals (Quick-connect spring-clamp terminals)

- N, L** Line input
- \oplus PE (Protective Earth) input

B Output Terminals (Quick-connect spring-clamp terminals, two pins per pole)

- +** Positive output
- Negative (return) output

C DC-OK Relay Contact (Quick-connect spring-clamp terminals)

The DC-OK relay contact is synchronized with the DC-OK LED. See chapter 8 for details.

D Output voltage potentiometer

Open the flap to adjust the output voltage. Factory set: 24.1V

E DC-OK LED (green)

On, when the output voltage is >90% of the adjusted output voltage

F Overload LED (red)

On, when the voltage on the output terminals is <90% of the adjusted output voltage, or in case of a short circuit in the output. Input voltage is required
Flashing, when the unit has switched off due to over-temperature.

Indicators, LEDs

| | Overload LED | DC-OK LED | DC-OK Contact |
|-------------------------------|--------------|-----------|---------------|
| Normal mode | OFF | ON | Closed |
| During BonusPower® | OFF | ON | Closed |
| Overload ($V_{out} < 90\%$) | ON | OFF | Open |
| Output short circuit | ON | OFF | Open |
| Temperature Shut-down | Intermitted | OFF | Open |
| No input power | OFF | OFF | Open |

14. EMC

The power supply is suitable for applications in industrial environment as well as in residential, commercial and light industry environment without any restrictions.

The CE mark indicates conformance with the EMC directive 2004/108/EC, the low-voltage directive (LVD) 2006/95/EC and the RoHS directive 2011/65/EC. A detailed EMC report is available on request.

| EMC Immunity | | According generic standards: EN 61000-6-1 and EN 61000-6-2 | | |
|--------------------------|---------------|---|---|--|
| Electrostatic discharge | EN 61000-4-2 | contact discharge air discharge | 8kV 15kV | Criterion A Criterion A |
| Electromagnetic RF field | EN 61000-4-3 | 80MHz-2.7GHz | 10V/m | Criterion A |
| Fast transients (Burst) | EN 61000-4-4 | input lines output lines DC-OK signal (coupling clamp) | 4kV 2kV 1kV | Criterion A Criterion A Criterion A |
| Surge voltage on input | EN 61000-4-5 | L → N L → PE, N → PE | 2kV 4kV | Criterion A Criterion A |
| Surge voltage on output | EN 61000-4-5 | + → - + / - → PE | 1kV 1kV | Criterion A Criterion A |
| Surge voltage on DC-OK | EN 61000-4-5 | DC-OK signal → PE | 1kV | Criterion A |
| Conducted disturbance | EN 61000-4-6 | 0.15-80MHz | 10V | Criterion A |
| Mains voltage dips | EN 61000-4-11 | 0% of 100Vac 40% of 100Vac 70% of 100Vac 0% of 200Vac 40% of 200Vac 70% of 200Vac | 0Vac, 20ms 40Vac, 200ms 70Vac, 500ms 0Vac, 20ms 80Vac, 200ms 140Vac, 500ms | Criterion A Criterion C Criterion A Criterion A Criterion A Criterion A |
| Voltage interruptions | EN 61000-4-11 | 0% of 200Vac (=0V) | 5000ms | Criterion C |
| Voltage sags | SEMI F47 0706 | dips on the input voltage according to SEMI F47 standard 80% of 120Vac (96Vac) 70% of 120Vac (84Vac) 50% of 120Vac (60Vac) | 1000ms 500ms 200ms | Criterion A Criterion A Criterion A |
| Powerful transients | VDE 0160 | over entire load range | 750V, 1.3ms | Criterion A |

Criteria:

A: Power supply shows normal operation behavior within the defined limits.

C: Temporary loss of function is possible. Power supply may shut-down and restarts by itself. No damage or hazards for the power supply will occur.

| EMC Emission | | According generic standards: EN 61000-6-3 and EN 61000-6-4 | |
|-------------------------------------|---|--|--|
| Conducted emission input lines | EN 55011, EN 55022, FCC Part 15, CISPR 11, CISPR 22 | Class B | |
| Conducted emission output lines **) | IEC/CISPR 16-1-2, IEC/CISPR 16-2-1 | limits for DC power port according EN 61000-6-3 fulfilled | |
| Radiated emission | EN 55011, EN 55022 | Class B | |
| Harmonic input current | EN 61000-3-2 | fulfilled for class A equipment | |
| Voltage fluctuations, flicker | EN 61000-3-3 | fulfilled *) | |

This device complies with FCC Part 15 rules.

Operation is subjected to following two conditions: (1) this device may not cause harmful interference, and (2) this device must accept any interference received, including interference that may cause undesired operation.

*) tested with constant current loads, non pulsing

**) for information only, not mandatory for EN 61000-6-3

| | | |
|------------------------------|--|----------------------------------|
| Switching Frequencies | The power supply has three converters with three different switching frequencies included. Two are nearly constant. The other one is input voltage and load dependent. | |
| Switching frequency 1 | 35kHz | nearly constant |
| Switching frequency 2 | 105kHz | nearly constant |
| Switching frequency 3 | 40kHz to 220kHz | input voltage and load dependent |

15. ENVIRONMENT

| | | |
|----------------------------|--|---|
| Operational temperature *) | -25°C to +70°C (-13°F to 158°F) | reduce output power according Fig. 15-1 |
| Storage temperature | -40 to +85°C (-40°F to 185°F) | for storage and transportation |
| Output de-rating | 6W/°C | 60-70°C (140°F to 158°F) |
| Humidity **) | 5 to 95% r.H. | IEC 60068-2-30 |
| Vibration sinusoidal | 2-17.8Hz: ±1.6mm; 17.8-500Hz: 2g 2 hours / axis | IEC 60068-2-6 |
| Shock | 30g 6ms, 20g 11ms 3 bumps / direction, 18 bumps in total | IEC 60068-2-27 |
| Altitude | 0 to 2000m (0 to 6 560ft) 2000 to 6000m (6 560 to 20 000ft) | without any restrictions reduce output power or ambient temperature, see Fig. 15-2 |
| Altitude de-rating | 15W/1000m or 5°C/1000m | IEC 62103, EN 50178, overvoltage category II > 2000m (6500ft), see Fig. 15-2 |
| Over-voltage category | III II | IEC 62103, EN 50178, altitudes up to 2000m altitudes from 2000m to 6000m |
| Degree of pollution | 2 | IEC 62103, EN 50178, not conductive |
| LABS compatibility | The unit does not release any silicone or other LABS-critical substances and is suitable for use in paint shops. | |

*) Operational temperature is the same as the ambient temperature and is defined as the air temperature 2cm below the unit.
 **) Do not energize while condensation is present

Fig. 15-1 Output current vs. ambient temp.

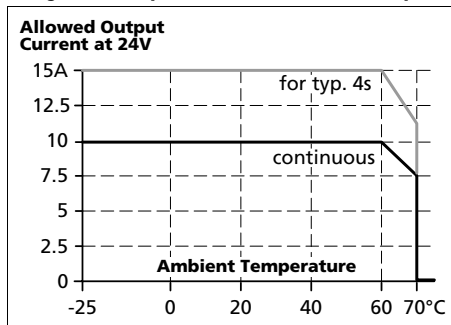
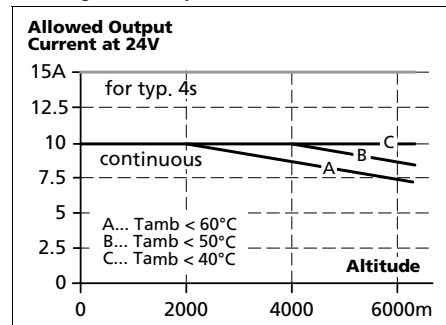

Fig. 15-2 Output current vs. altitude



16. PROTECTION FEATURES

| | | |
|--------------------------------|--|---|
| Output protection | Electronically protected against overload, no-load and short-circuits *) | |
| Output over-voltage protection | typ. 35Vdc max. 39Vdc | In case of an internal power supply defect, a redundant circuit limits the maximum output voltage. The output shuts down and automatically attempts to restart. |
| Degree of protection | IP 20 | EN/IEC 60529 |
| Penetration protection | > 3.5mm | e.g. screws, small parts |
| Over-temperature protection | yes | Output shut-down with automatic restart |
| Input transient protection | MOV (Metal Oxide Varistor) | |
| Internal input fuse | T6.3A H.B.C. | not user replaceable |

*) In case of a protection event, audible noise may occur.

17. SAFETY FEATURES

| | | |
|---------------------------------|---|--|
| Input / output separation *) | SELV PELV double or reinforced insulation | IEC/EN 60950-1 IEC/EN 60204-1, EN 50178, IEC 62103, IEC 60364-4-41 |
| Class of protection | I | PE (Protective Earth) connection required |
| Isolation resistance | > 5MΩ | input to output, 500Vdc |
| PE resistance | < 0.1Ω | |
| Touch current (leakage current) | typ. 0.19mA / 0.44mA typ. 0.29mA / 0.65mA typ. 0.53mA / 1.04mA < 0.25mA / 0.54mA < 0.38mA / 0.79mA < 0.74mA / 1.29mA | 100Vac, 50Hz, TN-,TT-mains / IT-mains 120Vac, 60Hz, TN-,TT-mains / IT-mains 230Vac, 50Hz, TN-,TT-mains / IT-mains 110Vac, 50Hz, TN-,TT-mains / IT-mains 132Vac, 60Hz, TN-,TT-mains / IT-mains 264Vac, 50Hz, TN-,TT-mains / IT-mains |

*) double or reinforced insulation

18. DIELECTRIC STRENGTH

The output voltage is floating and has no ohmic connection to the ground. Type and factory tests are conducted by the manufacturer. Field tests may be conducted in the field using the appropriate test equipment which applies the voltage with a slow ramp (2s up and 2s down). Connect all input-terminals together as well as all output poles before conducting the test. When testing, set the cut-off current settings to the value in the table below.

Fig. 18-1 Dielectric strength

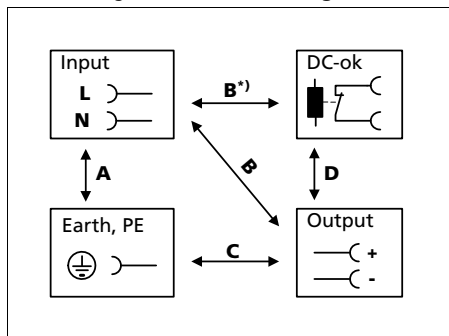









| | | A | B | C | D |
|-------------------------|-----|---------|---------|--------|--------|
| Type test | 60s | 2500Vac | 3000Vac | 500Vac | 500Vac |
| Factory test | 5s | 2500Vac | 2500Vac | 500Vac | 500Vac |
| Field test | 5s | 2000Vac | 2000Vac | 500Vac | 500Vac |
| Cut-off current setting | | > 10mA | > 10mA | > 20mA | > 1mA |

To fulfil the PELV requirements according to EN60204-1 § 6.4.1, we recommend that either the + pole, the - pole or any other part of the output circuit shall be connected to the protective earth system. This helps to avoid situations in which a load starts unexpectedly or can not be switched off when unnoticed earth faults occur.

B*) When testing input to DC-OK ensure that the max. voltage between DC-OK and the output is not exceeded (column D). We recommend connecting DC-OK pins and the output pins together when performing the test.

19. APPROVALS

| | | |
|---|---|--|
| EC Declaration of Conformity |  | The CE mark indicates conformance with the EMC directive 2004/108/EC, the low-voltage directive (LVD) 2006/95/EC and the RoHS directive 2011/65/EC. |
| EC Declaration of Conformity (additional for QS10.241-A1) |  | The CE mark indicates conformance with EMC directive 2004/108/EC and the ATEX directive 94/9/EC (Equipment and protection systems intended for use in potentially explosive atmospheres) |
| IEC 60950-1 2 nd Edition |  | CB Scheme, Information Technology Equipment |
| UL 508 |  | Listed for use as Industrial Control Equipment; U.S.A. (UL 508) and Canada (C22.2 No. 107-1-01); E-File: E198865 |
| UL 60950-1 2 nd Edition |  | Recognized for use as Information Technology Equipment, Level 5; U.S.A. (UL 60950-1) and Canada (C22.2 No. 60950-1); E-File: E137006 |
| ANSI / ISA 12.12.01-2007 (Class I Div 2) |  | Recognized for use in Hazardous Location Class I Div 2 T4 Groups A,B,C,D systems; U.S.A. (ANSI / ISA 12.12.01-2007) and Canada (C22.2 No. 213-M1987) The unit is suitable for use in Class I Division 2 Groups A, B, C, D locations. Substitution of components may impair suitability for Class I Division 2 environment. Do not disconnect equipment unless power has been switched off. Wiring must be in accordance with Class I, Division 2 wiring methods of the National Electrical Code, NFPA 70, and in accordance with other local or national codes. |
| EN 60079-15 ATEX (QS10.241-A1 only) |  | Suitable for use in Class 1 Zone 2 Groups IIa, IIb and IIc locations. Number of ATEX certificate: EPS 09 ATEX 1 236 X The power supply must be built-in in an IP54 enclosure. |
| Marine |  | GL (Germanischer Lloyd) classified and ABS (American Bureau for Shipping) PDA Environmental category: C, EMC 2 Marine and offshore applications |
| SEMI F47 |  | SEMI F47-0706 Ride-through compliance for semiconductor industry. Full SEMI range compliance (Input: AC120V or higher, output: < 240W) |

20. PHYSICAL DIMENSIONS AND WEIGHT

| | |
|-------------------------|--|
| Weight | 900g / 1.98lb |
| DIN-Rail | Use 35mm DIN-rails according to EN 60715 or EN 50022 with a height of 7.5 or 15mm. The DIN-rail height must be added to the unit depth (117mm) to calculate the total required installation depth. |
| Installation Clearances | See chapter 2 |

Fig. 20-1 **Front view**

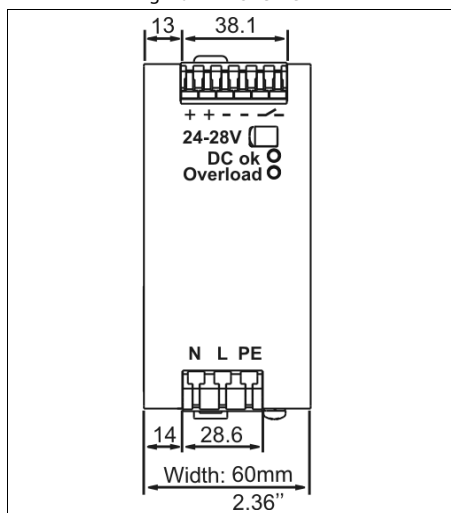
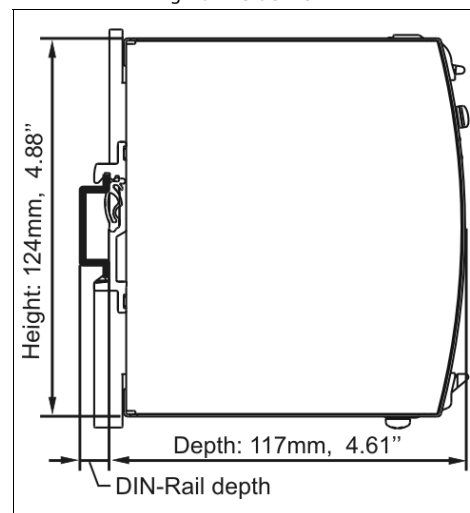

Fig. 20-2 **Side view**



21. ACCESSORIES

21.1. ZM1.WALL WALL MOUNTING BRACKET

This bracket is used to mount the power supply onto a flat surface without utilizing a DIN-Rail.

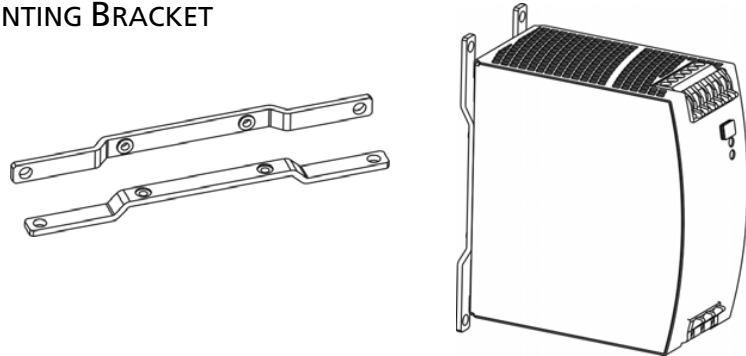

21.2. ZM13.SIDE SIDE MOUNTING BRACKET

This bracket is used to mount Dimension units sideways with or without utilizing a DIN-Rail. The two aluminum brackets and the black plastic slider of the unit have to be detached, so that the steel brackets can be mounted.

For sideways DIN-rail mounting, the removed aluminum brackets and the black plastic slider need to be mounted on the steel bracket.

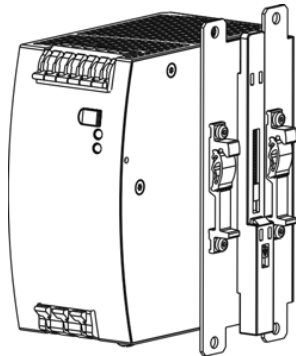

Side mounting with DIN-rail brackets

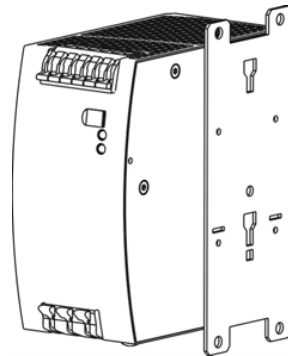

Side mounting without DIN-rail brackets

21.3. UF20.241 BUFFER MODULE

This buffer unit is a supplementary device for DC 24V power supplies. It delivers power to bridge typical mains failures or extends the hold-up time after turn-off of the AC power. In times when the power supply provides sufficient voltages, the buffer unit stores energy in integrated electrolytic capacitors. In case of mains voltage fault, this energy is released again in a regulated process. One buffer module can deliver 20A additional current. The buffer unit does not require any control wiring. It can be added in parallel to the load circuit at any given point. Buffer units can be added in parallel to increase the output ampacity or the hold-up time.

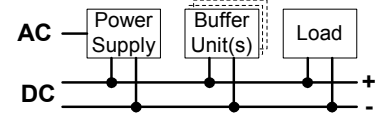

21.4. YR2.DIODE REDUNDANCY MODULE

The YR2.DIODE is a dual redundancy module, which has two diodes as decoupling devices included. It can be used for various purposes. The most popular application is to configure highly reliable and true redundant power supply systems. Another interesting application is the separation of sensitive loads from non-sensitive loads. This avoids the distortion of the power quality for the sensitive loads which can cause controller failures.

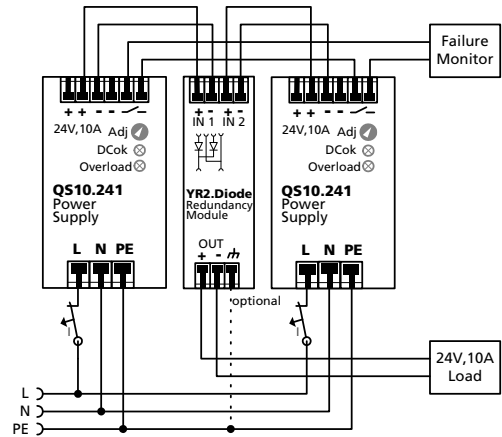

22. APPLICATION NOTES

22.1. REPETITIVE PULSE LOADING

Typically, a load current is not constant and varies over time. This power supply is designed to support loads with a higher short-term power demand (=BonusPower®). The short-term duration is hardware controlled by an output power manager and is available on a repeated basis. If the BonusPower® load lasts longer than the hardware controller allows it, the output voltage will dip and the next BonusPower® is available after the BonusPower® recovery time (see chapter 6) has elapsed.

To avoid this, the following rules must be met:

- The power demand of the pulse must be below 150% of the nominal output power.
- The duration of the pulse power must be shorter than the allowed BonusPower® time. (see output section)
- The average (R.M.S.) output current must be below the specified continuous output current.
If the R.M.S. current is higher, the unit will respond with a thermal shut-down after a period of time. Use the maximum duty cycle curve (Fig. 22-2) to check if the average output current is below the nominal current.

Fig. 22-1 Repetitive pulse loads, definitions

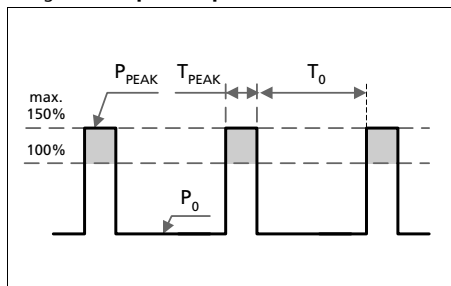

- P₀ Base load (W)
- P_{PEAK} Pulse load (above 100%)
- T₀ Duration between pulses (s)
- T_{PEAK} Pulse duration (s)

Fig. 22-2 Max. duty cycle curve

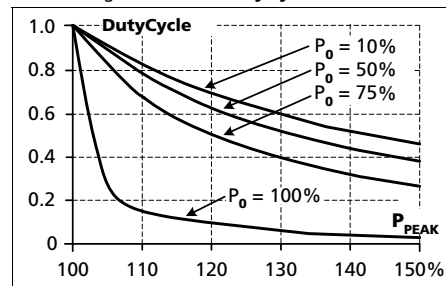

$$\text{DutyCycle} = \frac{T_{\text{peak}}}{T_{\text{peak}} + T_0}$$

$$T_0 = \frac{T_{\text{peak}} - (\text{DutyCycle} \times T_{\text{peak}})}{\text{DutyCycle}}$$

Example: A load is powered continuously with 120W (= 50% of the rated output load). From time to time a peak power of 360W (= 150% of the rated output load) is needed for 1 second.

The question is: How often can this pulse be supplied without overloading the power supply?

- Make a vertical line at P_{PEAK} = 150% and a horizontal line where the vertical line crosses the P₀ = 50% curve. Read the max. duty cycle from the duty cycle-axis (= 0.37)
- Calculate the required pause (base load) length T₀:
- Result: The required pause length = 1.7s
- Max. repetition rate = pulse +pause length = **2.7s**

$$T_0 = \frac{T_{\text{peak}} - (\text{DutyCycle} \times T_{\text{peak}})}{\text{DutyCycle}} = \frac{1\text{s} - (0.37 \times 1\text{s})}{0.37} = \mathbf{1.7\text{s}}$$

More examples for pulse load compatibility:

| P _{PEAK} | P ₀ | T _{PEAK} | T ₀ | P _{PEAK} | P ₀ | T _{PEAK} | T ₀ |
|-------------------|----------------|-------------------|----------------|-------------------|----------------|-------------------|----------------|
| 360W | 240W | 1s | >25s | 360W | 120W | 0.1s | >0.16s |
| 360W | 0W | 1s | >1.3s | 360W | 120W | 1s | >1.6s |
| 300W | 120W | 1s | > 0.75s | 360W | 120W | 3s | >4.9s |

22.2. PEAK CURRENT CAPABILITY

Solenoids, contactors and pneumatic modules often have a steady state coil and a pick-up coil. The inrush current demand of the pick-up coil is several times higher than the steady-state current and usually exceeds the nominal output current (including the PowerBoost). The same situation applies when starting a capacitive load.

Branch circuits are often protected with circuit breakers or fuses. In case of a short or an overload in the branch circuit, the fuse needs a certain amount of over-current to trip or to blow. The peak current capability ensures the safe operation of subsequent circuit breakers.

Assuming the input voltage is turned on before such an event, the built-in large sized output capacitors inside the power supply can deliver extra current. Discharging this capacitor causes a voltage dip on the output. The following two examples show typical voltage dips:

Fig. 22-3 Peak load with 2x the nominal current for 50ms, typ.

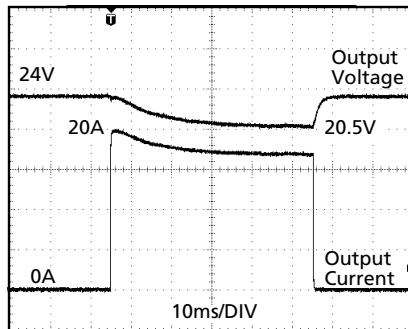

Peak load 20A (resistive) for 50ms
Output voltage dips from 24V to 20.5V.

Fig. 22-4 Peak load with 5x the nominal current for 5ms, typ.

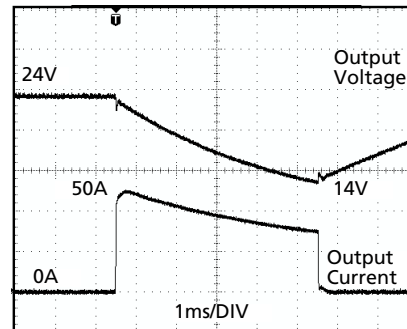

Peak load 50A (resistive) for 5ms
Output voltage dips from 24V to 14V.

Please note: The DC-OK relay triggers when the voltage dips more than 10% for longer than 1ms.

22.3. BACK-FEEDING LOADS

Loads such as decelerating motors and inductors can feed voltage back to the power supply. This feature is also called return voltage immunity or resistance against Back- E.M.F. (Electro Magnetic Force).

This power supply is resistant and does not show malfunctioning when a load feeds back voltage to the power supply. It does not matter whether the power supply is on or off.

The maximum allowed feed-back-voltage is 35Vdc. The absorbing energy can be calculated according to the built-in large sized output capacitor which is specified in chapter 6.

22.4. EXTERNAL INPUT PROTECTION

The unit is tested and approved for branch circuits up to 20A. An external protection is only required if the supplying branch has an ampacity greater than this. Check also local codes and local requirements. In some countries local regulations might apply.

If an external fuse is necessary or utilized, minimum requirements need to be considered to avoid nuisance tripping of the circuit breaker. A minimum value of 6A B- or 4A C-Characteristic breaker should be used

22.5. CHARGING OF BATTERIES

The power supply can be used to charge lead-acid or maintenance free batteries. (Two 12V batteries in series)

Instructions for charging batteries:

- a) Set output voltage (measured at no load and at the battery end of the cable) very precisely to the end-of-charge voltage.
- | | | | | |
|-----------------------|-------|-------|--------|-------|
| End-of-charge voltage | 27.8V | 27.5V | 27.15V | 26.8V |
| Battery temperature | 10°C | 20°C | 30°C | 40°C |
- b) Use a 15A or 16A circuit breaker (or blocking diode) between the power supply and the battery.
 - c) Ensure that the output current of the power supply is below the allowed charging current of the battery.
 - d) Use only matched batteries when putting 12V types in series.
 - e) The return current to the power supply (battery discharge current) is typ. 3mA when the power supply is switched off (except in case a blocking diode is utilized).

22.6. OUTPUT CIRCUIT BREAKERS

Standard miniature circuit breakers (MCB's or UL1077 circuit breakers) are commonly used for AC-supply systems and may also be used on 24V branches.

MCB's are designed to protect wires and circuits. If the ampere value and the characteristics of the MCB are adapted to the wire size that is used, the wiring is considered as thermally safe regardless of whether the MCB opens or not.

To avoid voltage dips and under-voltage situations in adjacent 24V branches which are supplied by the same source, a fast (magnetic) tripping of the MCB is desired. A quick shutdown within 10ms is necessary corresponding roughly to the ride-through time of PLC's. This requires power supplies with high current reserves and large output capacitors. Furthermore, the impedance of the faulty branch must be sufficiently small in order for the current to actually flow. The best current reserve in the power supply does not help if Ohm's law does not permit current flow. The following table has typical test results showing which B- and C-Characteristic MCBs magnetically trip depending on the wire cross section and wire length.

Fig. 22-5 Test circuit

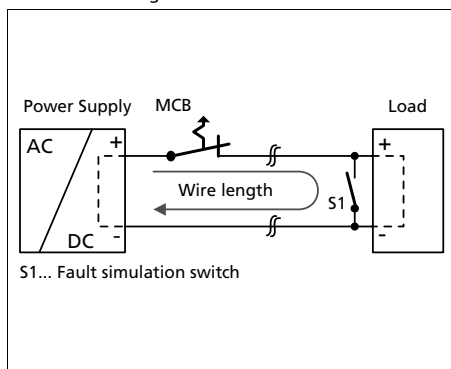

Maximal wire length*) for a fast (magnetic) tripping:

| | 0.75mm ² | 1.0mm ² | 1.5mm ² | 2.5mm ² |
|--------------|---------------------|--------------------|--------------------|--------------------|
| C-2A | 23m | 29m | 48m | 69m |
| C-3A | 20m | 24m | 38m | 57m |
| C-4A | 12m | 16m | 22m | 33m |
| C-6A | 5m | 7m | 9m | 14m |
| C-8A | 3m | 4m | 5m | 7m |
| C-10A | 2m | 3m | 4m | 6m |
| C-13A | 1m | 1m | 2m | 2m |
| B-6A | 11m | 14m | 24m | 34m |
| B-10A | 5m | 8m | 11m | 18m |
| B-13A | 4m | 6m | 8m | 10m |

*) Don't forget to consider twice the distance to the load (or cable length) when calculating the total wire length (+ and - wire).

22.7. PARALLEL USE TO INCREASE OUTPUT POWER

Power supplies from the same series (Q-Series) can be paralleled to increase the output power. The output voltage shall be adjusted to the same value ($\pm 100\text{mV}$) with the same load conditions on all units, or the units can be left with the factory settings.

If more than three units are connected in parallel, a fuse or circuit breaker with a rating of 15A or 16A is required on each output. Alternatively, a diode or redundancy module can also be utilized.

Keep an installation clearance of 15mm (left / right) between two power supplies and avoid installing the power supplies on top of each other. Do not use power supplies in parallel in mounting orientations other than the standard mounting orientation (input terminals on bottom and output terminals on the top of the unit) or in any other condition where a derating of the output current is required (e.g. altitude, above 60°C, ...).

Pay attention that leakage current, EMI, inrush current, harmonics will increase when using multiple power supplies.

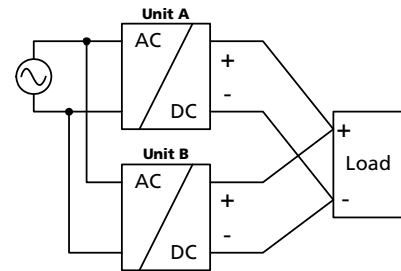

22.8. PARALLEL USE FOR REDUNDANCY

Power supplies can be paralleled for redundancy to gain higher system availability. Redundant systems require a certain amount of extra power to support the load in case one power supply unit fails. The simplest way is to put two power supplies in parallel. This is called a 1+1 redundancy. In case one power supply unit fails, the other one is automatically able to support the load current without any interruption. Redundant systems for a higher power demand are usually built in a N+1 method. E.g. five power supplies, each rated for 10A are paralleled to build a 40A redundant system. For N+1 redundancy the same restrictions apply as for increasing the output power, see also section 22.7.

Please note: This simple way to build a redundant system does not cover failures such as an internal short circuit in the secondary side of the power supply. In such a case, the defective unit becomes a load for the other power supplies and the output voltage can not be maintained any more. This can be avoided by utilizing decoupling diodes which are included in the redundancy module YR2.DIODE.

Recommendations for building redundant power systems:

- Use separate input fuses for each power supply.
- Monitor the individual power supply units. Therefore, use the DC-OK relay contact of the QS10 power supply.
- It is desirable to set the output voltages of all units to the same value ($\pm 100\text{mV}$) or leave it at the factory setting.

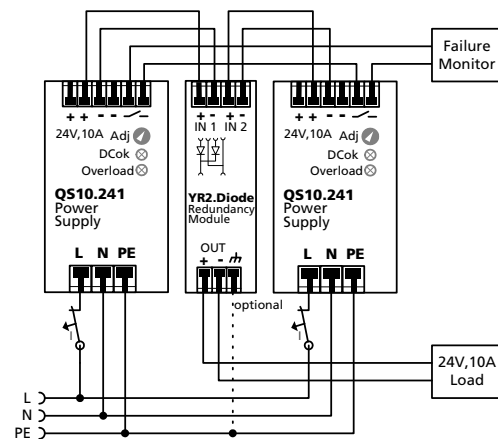

22.9. DAISY CHAINING OF OUTPUTS

Daisy chaining (jumping from one power supply output to the next) is allowed as long as the average output current through one terminal pin does not exceed 25A. If the current is higher, use a separate distribution terminal block as shown in Fig. 22-7.

Fig. 22-6 Daisy chaining of outputs

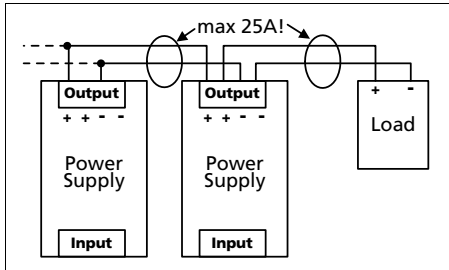
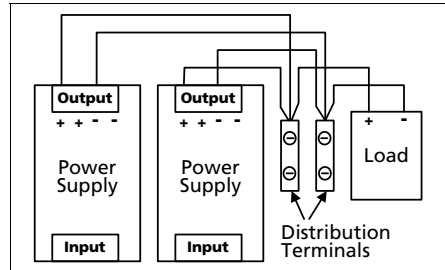

Fig. 22-7 Using distribution terminals



22.10. SERIES OPERATION

Power supplies of the same type can be connected in series for higher output voltages. It is possible to connect as many units in series as needed, providing the sum of the output voltage does not exceed 150Vdc. Voltages with a potential above 60Vdc are not SELV any more and can be dangerous. Such voltages must be installed with a protection against touching.

Earthing of the output is required when the sum of the output voltage is above 60Vdc.

Avoid return voltage (e.g. from a decelerating motor or battery) which is applied to the output terminals.

Keep an installation clearance of 15mm (left / right) between two power supplies and avoid installing the power supplies on top of each other. Do not use power supplies in series in mounting orientations other than the standard mounting orientation (input terminals on bottom and output terminals on the top of the unit).

Pay attention that leakage current, EMI, inrush current, harmonics will increase when using multiple power supplies.

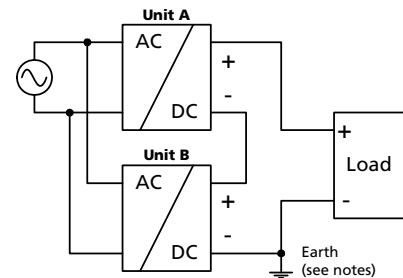

22.11. INDUCTIVE AND CAPACITIVE LOADS

The unit is designed to supply any kind of loads, including unlimited capacitive and inductive loads.

22.12. OPERATION ON TWO PHASES

The power supply can also be used on two-phases of a three-phase-system. Such a phase-to-phase connection is allowed as long as the supplying voltage is below 240V+15%. Use a fuse or a circuit breaker to protect the N input. The N input is internally not protected and is in this case connected to a hot wire. Appropriate fuses or circuit breakers are specified in section 22.4 "External Input Protection".

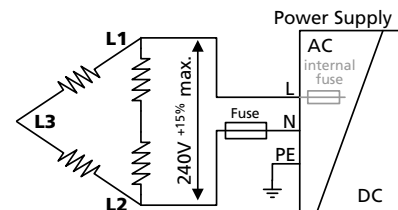

22.13. USE IN A TIGHTLY SEALED ENCLOSURE

When the power supply is installed in a tightly sealed enclosure, the temperature inside the enclosure will be higher than outside. In such situations, the inside temperature defines the ambient temperature for the power supply.

The following measurement results can be used as a reference to estimate the temperature rise inside the enclosure.

The power supply is placed in the middle of the box, no other heat producing items are inside the box

| | |
|--------------------------------|---|
| Enclosure: | Rittal Typ IP66 Box PK 9519 100, plastic, 180x180x165mm |
| Load: | 24V, 8A; (=80%) load is placed outside the box |
| Input: | 230Vac |
| Temperature inside enclosure: | 47°C (in the middle of the right side of the power supply with a distance of 2cm) |
| Temperature outside enclosure: | 27°C |
| Temperature rise: | 20K |

22.14. MOUNTING ORIENTATIONS

Mounting orientations other than input terminals on the bottom and output on the top require a reduction in continuous output power or a limitation in the maximum allowed ambient temperature. The amount of reduction influences the lifetime expectancy of the power supply. Therefore, two different derating curves for continuous operation can be found below:

Curve A1 Recommended output current.

Curve A2 Max allowed output current (results in approximately half the lifetime expectancy of A1).

Fig. 22-8
Mounting Orientation A
(Standard orientation)

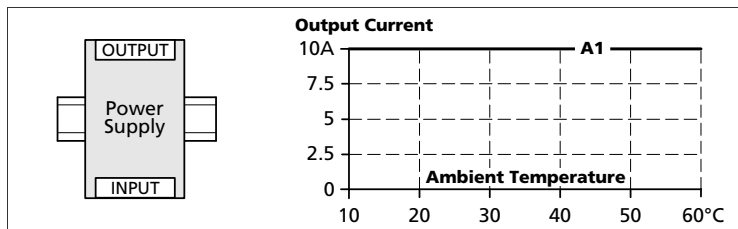

Fig. 22-9
Mounting Orientation B
(Upside down)

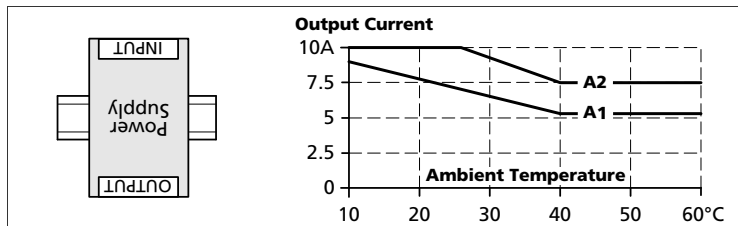

Fig. 22-10
Mounting Orientation C
(Table-top mounting)

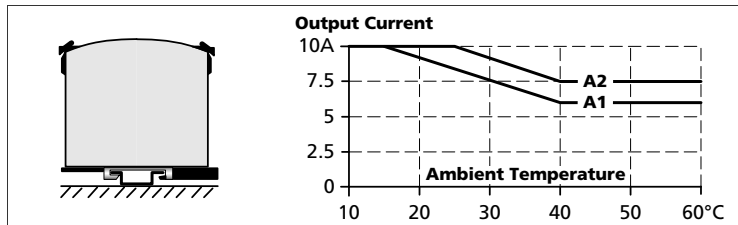

Fig. 22-11
Mounting Orientation D
(Horizontal cw)

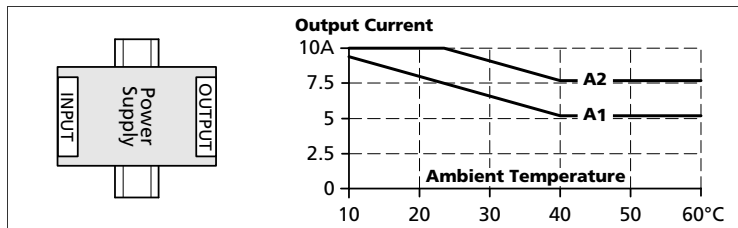

Fig. 22-12
Mounting Orientation E
(Horizontal ccw)

