



POWER SUPPLY

- AC 200-240 Single-Phase Input
- Width only 32mm
- Efficiency up to 90.2%
- Easy Fuse Breaking due to High Overload Peak Current
- 20% Output Power Reserves
- Full Power up to +60°C
- 3 Year Warranty

GENERAL DESCRIPTION

The DIMENSION C-Line units are cost optimized power supplies without compromising quality, reliability and performance. The C-Line is part of the DIMENSION power supply family, existing alongside the high featured Q-Line.

The CS5.244 includes all the essential basic functions and the devices have a power reserve of 20%. This extra current may even be used continuously at temperatures up to +45°C.

The most important features are the small size, high efficiency and the wide temperature range.

The unit also has an input for 200-240V mains only. This supports regional applications and offers additional cost savings without sacrificing functionality.

High immunity to transients and power surges as well as low electromagnetic emission and a large international approval package for a variety of applications makes this unit suitable for nearly every situation.

SHORT-FORM DATA

Output voltage	DC 24V	
Adjustment range	24 - 28V	
Output current	5A	at 24V, amb <60°C
	6A	at 24V, amb <45°C
	4.3A	at 28V, amb <60°C
	5.1A	at 28V, amb <45°C
Output power	120W	ambient <60°C
	144W	ambient <45°C
Output ripple	< 50mVpp	20Hz to 20MHz
AC Input voltage	AC 200-240V	±10%
Mains frequency	50-60Hz	±6%
AC Input current	1.16A	at 230Vac
DC Input voltage	-	not allowed
Power factor	0.5	at 230Vac
AC Inrush current	30A peak	at 230Vac
Efficiency	90.2%	at 230Vac
Losses	13.2W	at 230Vac
Temperature range	-10°C to +70°C	operational
	Derating *)	3W/°C
Hold-up time	78ms	at 230Vac
Dimensions	32x124x117mm	WxHxD
Weight	500g / 1.1lb	

ORDER NUMBERS

Power Supply	CS5.244	24-28V Standard unit (AC 200-240V-Version)
Accessory	ZM1.WALL	Wall mount bracket
	ZM13.SIDE	Side mount bracket
	YRM2.DIODE	Redundancy module

MARKINGS





INDEX

	Page		Page
1. Intended Use	3	20. Physical Dimensions and Weight	17
2. Installation Requirements	3	21. Accessories	18
3. AC-Input	4	21.1. ZM1.WALL - Wall Mounting Bracket	18
4. DC-Input	5	21.2. ZM13.SIDE - Side Mounting Bracket	18
5. Input Inrush Current	5	21.3. Redundancy Modules	19
6. Output	6	22. Application Notes	20
7. Hold-up Time	7	22.1. Peak Current Capability	20
8. Efficiency and Power Losses	8	22.2. Back-feeding Loads	21
9. Lifetime Expectancy and MTBF	9	22.3. External Input Protection	21
10. Functional Diagram	9	22.4. Parallel Use to Increase Output Power	21
11. Terminals and Wiring	10	22.5. Parallel Use for Redundancy	21
12. Front Side and User Elements	11	22.6. Series Operation	22
13. EMC	12	22.7. Inductive and Capacitive Loads	22
14. Environment	13	22.8. Charging of Batteries	22
15. Protection Features	14	22.9. Operation on Two Phases	22
16. Safety Features	14	22.10. Use in a Tightly Sealed Enclosure	22
17. Dielectric Strength	15	22.11. Mounting Orientations	23
18. Approvals	16		
19. RoHS, REACH and Other Fulfilled Standards ...	16		

The information presented in this document is believed to be accurate and reliable and may change without notice. No part of this document may be reproduced or utilized in any form without permission in writing from the publisher.

TERMINOLOGY, ABBREVIATIONS AND DEFINITIONS

PE and  symbol	PE is the abbreviation for Protective Earth and has the same meaning as the symbol  .
Earth, Ground	This document uses the term "earth" which is the same as the U.S. term "ground".
T.b.d.	To be defined, value or description will follow later.
AC 230V	A figure displayed with the AC or DC before the value represents a nominal voltage with standard tolerances (usually $\pm 15\%$) included. E.g.: DC 12V describes a 12V battery disregarding whether it is full (13.7V) or flat (10V)
230Vac	A figure with the unit (Vac) at the end is a momentary figure without any additional tolerances included.
50Hz vs. 60Hz	As long as not otherwise stated, AC 230V parameters are valid at 50Hz mains frequency.
may	A key word indicating flexibility of choice with no implied preference.
shall	A key word indicating a mandatory requirement.
should	A key word indicating flexibility of choice with a strongly preferred implementation.

1. INTENDED USE

This device is designed for installation in an enclosure and is intended for the general professional use such as in industrial control, office, communication, and instrumentation equipment.

Do not use this power supply in equipment, where malfunction may cause severe personal injury or threaten human life.

This device is designed for use in hazardous, non-hazardous, ordinary or unclassified locations.

2. INSTALLATION REQUIREMENTS

This device may only be installed and put into operation by qualified personnel.

This device does not contain serviceable parts. The tripping of an internal fuse is caused by an internal defect.

If damage or malfunction should occur during installation or operation, immediately turn power off and send unit to the factory for inspection.

Mount the unit on a DIN-rail so that the input terminals are located on the bottom of the unit. For other mounting orientations see de-rating requirements in this document. See chapter 24.13.

This device is designed for convection cooling and does not require an external fan. Do not obstruct airflow and do not cover ventilation grid (e.g. cable conduits) by more than 15%!

Keep the following installation clearances: 40mm on top, 20mm on the bottom, 5mm on the left and right sides are recommended when the device is loaded permanently with more than 50% of the rated power. Increase this clearance to 15mm in case the adjacent device is a heat source (e.g. another power supply).

A disconnecting means shall be provided for the output of the power supplies when used in applications according to CSA C22.2 No 107.1-01.



WARNING Risk of electrical shock, fire, personal injury or death.

- Do not use the power supply without proper grounding (Protective Earth). Use the terminal on the input block for earth connection and not one of the screws on the housing.
- Turn power off before working on the device. Protect against inadvertent re-powering.
- Make sure that the wiring is correct by following all local and national codes.
- Do not modify or repair the unit.
- Do not open the unit as high voltages are present inside.
- Use caution to prevent any foreign objects from entering the housing.
- Do not use in wet locations or in areas where moisture or condensation can be expected.
- Do not touch during power-on, and immediately after power-off. Hot surfaces may cause burns.

Notes for use in hazardous location areas:

The power supply is suitable for use in Class I Division 2 Groups A, B, C, D locations.

WARNING EXPLOSION HAZARDS!

Substitution of components may impair suitability for this environment. Do not disconnect the unit or operate the voltage adjustment unless power has been switched off or the area is known to be non-hazardous.

3. AC-INPUT

AC input	nom.	AC 200-240V	±10%
Mains network systems		TN, TT or IT	
AC input range	min.	180-264Vac	continuous operation
		264-300Vac	max. 500ms
Allowed voltage L or N to earth	max.	300Vac	continuous, IEC 62103
Input frequency	nom.	50–60Hz	±6%
Turn-on voltage	typ.	105Vac	steady-state value, see Fig. 3-1
Shut-down voltage	typ.	95Vac	steady-state value, see Fig. 3-1
Input current	typ.	1.16A	at 24V, 5A, see Fig. 3-3
Power factor ^{*)}	typ.	0.5	at 24V, 5A, see Fig. 3-4
Crest factor ^{**)}	typ.	3.7	at 24V, 5A
Start-up delay	typ.	130ms	see Fig. 3-2
Rise time	typ.	8ms	at 24V, 5A const. current load, 0mF load capacitance, see Fig. 3-2
	typ.	25ms	at 24V, 5A const. current load, 5mF load capacitance,, see Fig. 3-2
Turn-on overshoot	max.	400mV	see Fig. 3-2
External input protection	See recommendations in chapter 22.3.		

*) The power factor is the ratio of the true (or real) power to the apparent power in an AC circuit.

**) The crest factor is the mathematical ratio of the peak value to RMS value of the input current waveform.

Fig. 3-1 Input voltage ranges

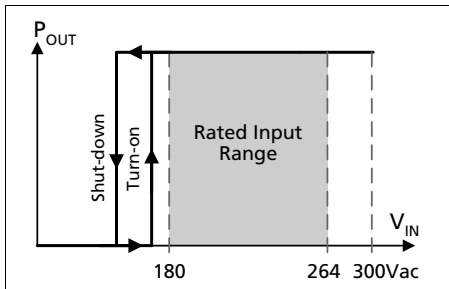

Fig. 3-3 Input current vs. output load at 24V

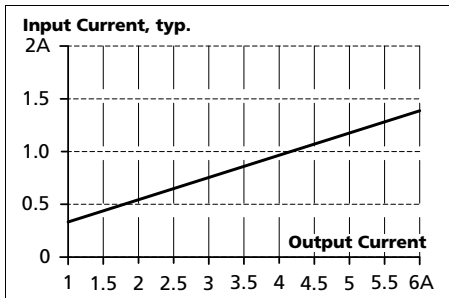

Fig. 3-2 Turn-on behavior, definitions

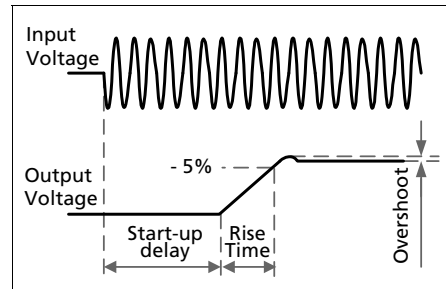
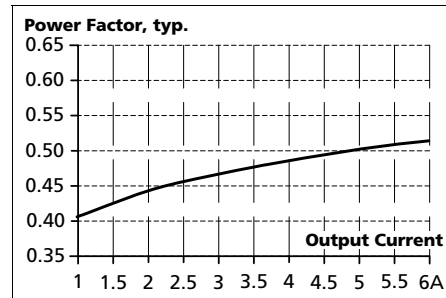

Fig. 3-4 Power factor vs. output load



4. DC-INPUT

Do not operate this power supply with DC-input voltage. Use the Q55.241 unit instead.

5. INPUT INRUSH CURRENT

After turn-on of the input voltage, an active inrush limitation circuit limits the input inrush current. Virtually no input inrush current is generated.

The charging current into the EMI suppression capacitors is disregarded in the first microseconds after switch-on.

Inrush current	max.	38A _{peak}	at 230Vac, +40°C ambient, cold start
	typ.	30A _{peak}	at 230Vac, +40°C ambient, cold start
Inrush energy	max.	1A ² s	at 230Vac, +40°C ambient, cold start

Fig. 5-1 Typical input inrush current behavior

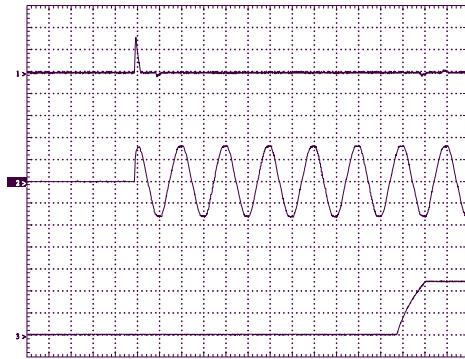

Input: 230Vac
 Output: 24V, 5A
 Ambient: +40°C

Upper curve: Input current (20A / DIV)
 Medium curve: Input voltage (200V / DIV)
 Lower curve: Output voltage (10V / DIV)
 Time scale: 10ms / DIV

6. OUTPUT

Output voltage	nom.	24V	
Adjustment range	min.	24-28V	guaranteed
	max.	30V ^{***)}	at clockwise end position of potentiometer
Factory settings	typ.	24.1V	±0.2%, at full load, cold unit,
Line regulation	max.	70mV	180-300Vac
Load regulation	max.	100mV	static value, 0A → 5A; see Fig. 6-1
Ripple and noise voltage	max.	50mVpp	20Hz to 20MHz, 50Ohm
Output current	nom.	5A	at 24V, ambient temperature <60°C, see Fig. 6-1
	nom.	6A ^{*)}	at 24V, ambient temperature <45°C
	nom.	3.75A	at 24V and 70°C ambient temperature
	nom.	4.3A	at 28V, ambient temperature <60°C, see Fig. 6-1
	nom.	5.1A ^{*)}	at 28V, ambient temperature <45°C, see Fig. 6-1
	nom.	3.2A	at 28V and 70°C ambient temperature
Reduce output current linearly between +45°C and +70°C			
Output power	nom.	120W	continuously available
	nom.	144W ^{*)}	Power Boost ^{*)}
Overload behavior		continuous current	see Fig. 6-1
Short-circuit current	min.	10A ^{**)}	load impedance <200mOhm, see Fig. 6-1
	max.	14A ^{**)}	load impedance <200mOhm, see Fig. 6-1
Output capacitance	typ.	1 800µF	included inside the power supply

***) Power Boost**

This power/ current is continuously allowed up to an ambient temperature of 45°C. Above 45°C, do not use this power/ current longer than a duty cycle of 10% and/ or not longer than 1 minute every 10 minutes.

****)** Discharge current of output capacitors is not included.

*****)** This is the maximum output voltage which can occur at the clockwise end position of the potentiometer due to tolerances. It is not a guaranteed value which can be achieved. The typical value is about 28.5V.

Fig. 6-1 **Output voltage vs. output current, typ.**

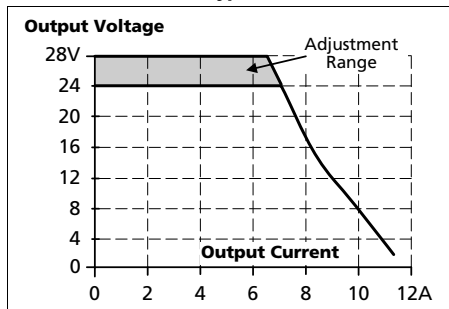

7. HOLD-UP TIME

Hold-up Time	typ.	161ms	at 230Vac, 24V, 2.5A, see Fig. 7-1
	min.	128ms	at 230Vac, 24V, 2.5A, see Fig. 7-1
	typ.	78ms	at 230Vac, 24V, 5A, see Fig. 7-1
	min.	62ms	at 230Vac, 24V, 5A, see Fig. 7-1
	typ.	63ms	at 230Vac, 24V, 6A, see Fig. 7-1
	min.	50ms	at 230Vac, 24V, 6A, see Fig. 7-1

Fig. 7-1 Hold-up time vs. input voltage

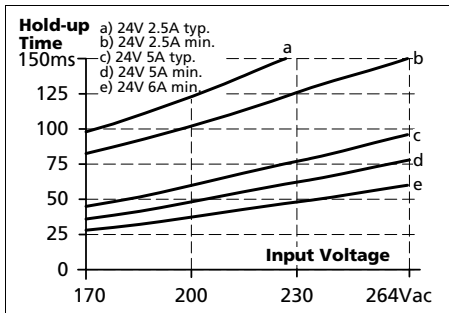
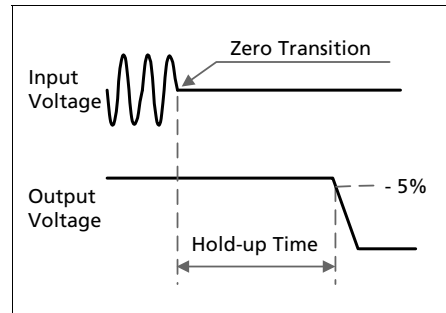

Fig. 7-2 Shut-down behavior, definitions



Note: At no load, the hold-up time can be up to several seconds. The green DC-OK lamp is on during this time.

8. EFFICIENCY AND POWER LOSSES

Efficiency	typ.	90.2%	at 230Vac, 24V, 5A
	typ.	90.0%	at 230Vac, 24V, 6A (Power Boost)
Average efficiency*)	typ.	88.2%	25% at 1.25A, 25% at 2.5A, 25% at 3.75A, 25% at 5A
Power losses	typ.	1.2W	at 230Vac, 24V, 0A
	typ.	7.7W	at 230Vac, 24V, 2.5A
	typ.	13.2W	at 230Vac, 24V, 5A
	typ.	16.1W	at 230Vac, 24V, 6A (Power Boost)

*) The average efficiency is an assumption for a typical application where the power supply is loaded with 25% of the nominal load for 25% of the time, 50% of the nominal load for another 25% of the time, 75% of the nominal load for another 25% of the time and with 100% of the nominal load for the rest of the time.

Fig. 8-1 Efficiency vs. output current at 24V, typ

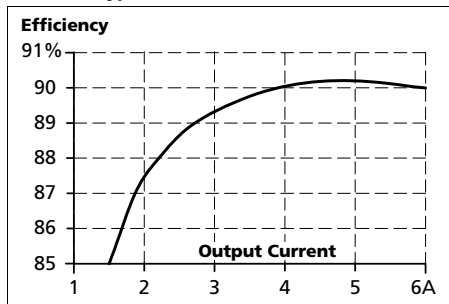

Fig. 8-2 Losses vs. output current at 24V, typ.

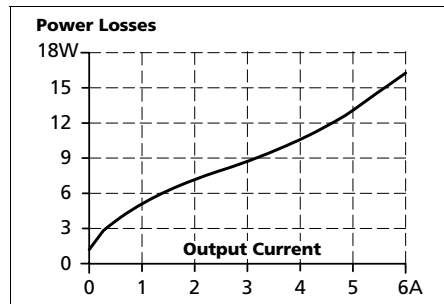

Fig. 8-3 Efficiency vs. input voltage at 24V, 5A, typ.

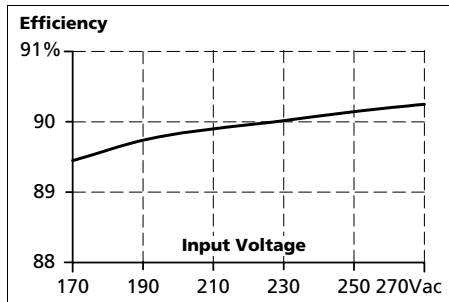
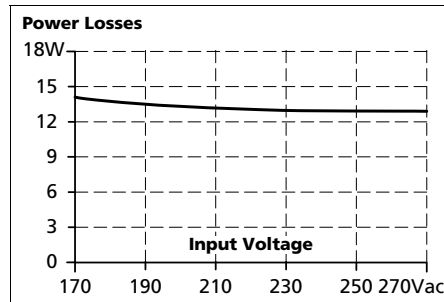

Fig. 8-4 Losses vs. input voltage at 24V, 5A, typ.



9. LIFETIME EXPECTANCY AND MTBF

Lifetime expectancy ^{*)}	144 000h ^{*)}	at 230Vac, 24V, 2.5A and 40°C
	408 000h ^{*)}	at 230Vac, 24V, 2.5A and 25°C
	72 000h	at 230Vac, 24V, 5A and 40°C
	204 000h ^{*)}	at 230Vac, 24V, 5A and 25°C
	42 000h	at 230Vac, 24V, 6A and 40°C
	120 000h ^{*)}	at 230Vac, 24V, 6A and 25°C
MTBF ^{**) SN 29500, IEC 61709}	940 000h	at 230Vac, 24V, 5A and 40°C
	799 000h	at 230Vac, 24V, 6A and 40°C
	1 626 000h	at 230Vac, 24V, 5A and 25°C
MTBF ^{**) MIL HDBK 217F}	680 000h	at 230Vac, 24V, 5A and 40°C; Ground Benign GB40
	612 000h	at 230Vac, 24V, 6A and 40°C; Ground Benign GB40
	932 000h	at 230Vac, 24V, 5A and 25°C; Ground Benign GB25

*) The **Lifetime expectancy** shown in the table indicates the minimum operating hours (service life) and is determined by the lifetime expectancy of the built-in electrolytic capacitors. Lifetime expectancy is specified in operational hours and is calculated according to the capacitor's manufacturer specification. The manufacturer of the electrolytic capacitors only guarantees a maximum life of up to 15 years (131 400h). Any number exceeding this value is a calculated theoretical lifetime which can be used to compare devices.

) **MTBF stands for **Mean Time Between Failure**, which is calculated according to statistical device failures, and indicates reliability of a device. It is the statistical representation of the likelihood of a unit to fail and does not necessarily represent the life of a product. The MTBF figure is a statistical representation of the likelihood of a device to fail. A MTBF figure of e.g. 1 000 000h means that statistically one unit will fail every 100 000 units are installed in the field. However, it can not be determined if the failed unit has been running for 50 000h or only for 100h.

10. FUNCTIONAL DIAGRAM

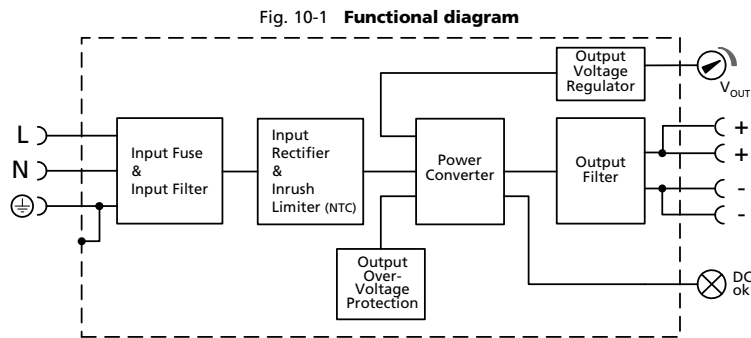

11. TERMINALS AND WIRING

The terminals are IP20 Finger safe constructed and suitable for field- and factory wiring.

Type	Screw terminals
Solid wire	0.5-6mm ²
Stranded wire	0.5-4mm ²
American Wire Gauge	AWG20-10
Max. wire diameter	2.8mm (including ferrules)
Wire stripping length	7mm / 0.28inch
Screwdriver	3.5mm slotted or cross-head No 2
Recommended tightening torque	1Nm, 9lb.in
Pull-out force	according to UL 486E

Instructions:

- a) Use appropriate copper cables that are designed for minimum operating temperatures of:
 60°C for ambient up to 45°C and
 75°C for ambient up to 60°C minimum
 90°C for ambient up to 70°C minimum.
- b) Follow national installation codes and installation regulations!
- c) Ensure that all strands of a stranded wire enter the terminal connection!
- d) Do not use the unit without PE connection.
- e) Unused terminal compartments should be securely tightened.
- f) Ferrules are allowed.

12. FRONT SIDE AND USER ELEMENTS

Fig. 12-1 Front side



A Input Terminals (screw terminals)

- N, L** Line input
- ⊕ PE (Protective Earth) input

B Output Terminals (screw terminals, two pins per pole)

- + Positive output
- Negative (return) output

C Output voltage potentiometer

Open the flap to adjust the output voltage. Factory set: 24.1V

D DC-OK LED (green)

On, when the voltage on the output terminals is >21V

13. EMC

The power supply is suitable for applications in industrial environment as well as in residential, commercial and light industry environment.

A detailed EMC report is available on request.

EMC Immunity		According generic standards: EN 61000-6-1 and EN 61000-6-2		
Electrostatic discharge	EN 61000-4-2	contact discharge air discharge	8kV 15kV	Criterion A Criterion A
Electromagnetic RF field	EN 61000-4-3	80MHz-2.7GHz	10V/m	Criterion A
Fast transients (Burst)	EN 61000-4-4	input lines output lines	4kV 2kV	Criterion A Criterion A
Surge voltage on input	EN 61000-4-5	L → N L → PE, N → PE	2kV 4kV	Criterion A Criterion A
Surge voltage on output	EN 61000-4-5	+ → - + / - → PE	500V 1kV	Criterion A Criterion A
Conducted disturbance	EN 61000-4-6	0.15-80MHz	10V	Criterion A
Mains voltage dips	EN 61000-4-11	0% of 200Vac 40% of 200Vac 70% of 200Vac	0Vac, 20ms 80Vac, 200ms 140Vac, 500ms	Criterion A Criterion C Criterion A
Voltage interruptions	EN 61000-4-11		5000ms	Criterion C
Powerful transients	VDE 0160	over entire load range	750V, 1.3ms	Criterion A

Criteria:

A: Power supply shows normal operation behavior within the defined limits.

B: Temporary voltage dips possible. No change in operation mode.

C: Temporary loss of function is possible. Power supply may shut-down and restarts by itself. No damage or hazards for the power supply will occur.

EMC Emission		According generic standards: EN 61000-6-3, EN 61000-6-4	
Conducted emission input lines	EN 55011, EN 55022, FCC Part 15, CISPR 11, CISPR 22	Class B	
Conducted emission output lines**)	IEC/CISPR 16-1-2, IEC/CISPR 16-2-1	limits for DC power port according EN 61000-6-3 not fulfilled	
Radiated emission	EN 55011, EN 55022	Class B	
Harmonic input current	EN 61000-3-2	fulfilled	
Voltage fluctuations, flicker	EN 61000-3-3	fulfilled*)	

This device complies with FCC Part 15 rules.

Operation is subjected to following two conditions: (1) this device may not cause harmful interference, and (2) this device must accept any interference received, including interference that may cause undesired operation.

*) tested with constant current loads, non pulsing

***) for information only, not mandatory for EN 61000-6-3

Switching frequency	175kHz to 225kHz	Main converter, input voltage dependent at 24V, 2.5A
	100kHz to 130kHz	Main converter, input voltage dependent at 24V, 5A

14. ENVIRONMENT

Operational temperature ^{*)}	-10°C to +70°C (14°F to 158°F)	reduce output power according Fig. 14-1
Storage temperature	-40°C to +85°C (-40°F to 185°F)	for storage and transportation
Output de-rating	1.6W/°C 3W/°C	45°C to 60°C (113°F to 140°F) 60°C to 70°C (140°F to 158°F)
Humidity ^{**)}	5 to 95% r.h.	IEC 60068-2-30
Vibration sinusoidal	2-17.8Hz: ±1.6mm; 17.8-500Hz: 2g ^{***)} 2 hours / axis ^{***)}	IEC 60068-2-6
Shock	30g 6ms, 20g 11ms ^{***)} 3 bumps / direction, 18 bumps in total	IEC 60068-2-27
Altitude	0 to 2000m (0 to 6 560ft) 2000 to 6000m (6 560 to 20 000ft)	without any restrictions reduce output power or ambient temperature, see Fig. 14-2 IEC 62103, EN 50178, overvoltage category II > 2000m (6500ft), see Fig. 14-2
Altitude de-rating	7.5W/1000m or 5°C/1000m	
Over-voltage category	III II	IEC 62103, EN 50178, altitudes up to 2000m altitudes from 2000m to 6000m
Degree of pollution	2	IEC 62103, EN 50178, not conductive
LABS compatibility	The unit does not release any silicone or other LABS-critical substances and is suitable for use in paint shops.	

*) Operational temperature is the same as the ambient or surrounding temperature and is defined as the air temperature 2cm below the unit.

***) Do not energize while condensation is present

***) Tested in combination with DIN-Rails according to EN 60715 with a height of 15mm and a thickness of 1.3mm and standard orientation.

Fig. 14-1 Output current vs. ambient temp.

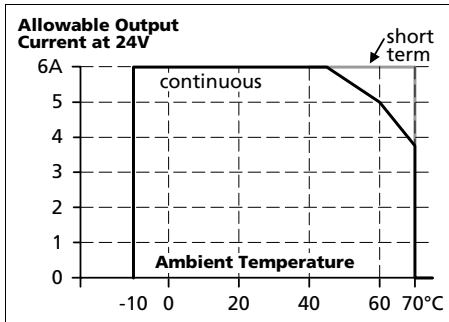
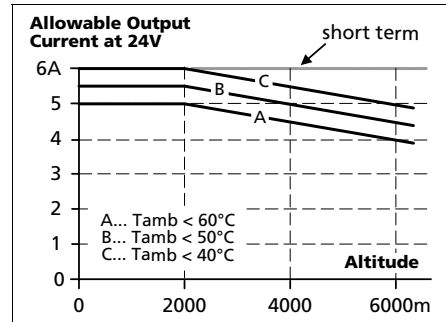

Fig. 14-2 Output current vs. altitude



15. PROTECTION FEATURES

Output protection	Electronically protected against overload, no-load and short-circuits ^{*)}	
Output over-voltage protection	typ. 35Vdc max. 39Vdc	In case of an internal power supply defect, a redundant circuit limits the maximum output voltage. The output shuts down and automatically attempts to restart.
Degree of protection	IP 20	EN/IEC 60529 Caution: For use in a controlled environment according to CSA 22.2 No 107.1-01.
Penetration protection	> 3.5mm	e.g. screws, small parts
Over-temperature protection	yes	Output shut-down with automatic restart
Input transient protection	MOV (Metal Oxide Varistor)	
Internal input fuse	included	not user replaceable

^{*)} In case of a protection event, audible noise may occur.

16. SAFETY FEATURES

Input / output separation ^{*)}	SELV PELV double or reinforced insulation	IEC/EN 60950-1 IEC/EN 60204-1, EN 50178, IEC 62103, IEC 60364-4-41
Class of protection	I	PE (Protective Earth) connection required
Isolation resistance	> 5MΩ	input to output, 500Vdc
PE resistance	< 0.1Ω	between housing and PE terminal
Touch current (leakage current)	typ. 0.40mA / 0.67mA max. 0.60mA / 1.09mA	230Vac, 50Hz, TN-,TT-mains / IT-mains 264Vac, 50Hz, TN-,TT-mains / IT-mains

17. DIELECTRIC STRENGTH

The output voltage is floating and has no ohmic connection to the ground. Type and factory tests are conducted by the manufacturer. Field tests may be conducted in the field using the appropriate test equipment which applies the voltage with a slow ramp (2s up and 2s down). Connect all input-terminals together as well as all output poles before conducting the test. When testing, set the cut-off current settings to the value in the table below.

Fig. 17-1 Dielectric strength

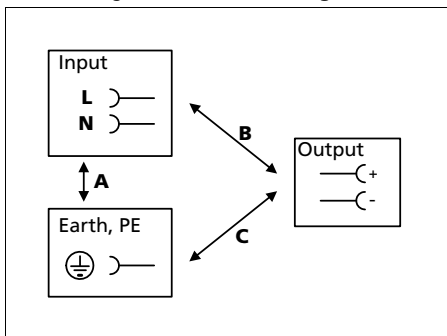

		A	B	C
Type test	60s	2500Vac	3000Vac	500Vac
Factory test	5s	2500Vac	2500Vac	500Vac
Field test	5s	2000Vac	2000Vac	500Vac
Cut-off current setting		> 10mA	> 10mA	> 20mA

To fulfil the PELV requirements according to EN60204-1 § 6.4.1, we recommend that either the + pole, the – pole or any other part of the output circuit shall be connected to the protective earth system. This helps to avoid situations in which a load starts unexpectedly or can not be switched off when unnoticed earth faults occur.

18. APPROVALS

EC Declaration of Conformity



The CE mark indicates conformance with the
 - EMC directive 2004/108/EC and the
 - Low-voltage directive (LVD) 2006/95/EC

IEC 60950-1
2nd Edition

CB Scheme,
 Information Technology Equipment

UL 508



Listed for use as Industrial Control Equipment;
 U.S.A. (UL 508) and Canada (C22.2 No. 107-1-01);
 E-File: E198865

UL 60950-1
2nd Edition

Recognized for use as Information Technology Equipment,
 Level 5; U.S.A. (UL 60950-1) and Canada (C22.2 No. 60950-1);
 E-File: E137006
 Applicable for altitudes up to 2000m.

ANSI / ISA 12.12.01-2007
Class I Div 2

Recognized for use in Hazardous Location Class I Div 2 T3
 Groups A,B,C,D systems; U.S.A. (ANSI / ISA 12.12.01-2007) and
 Canada (C22.2 No. 213-M1987)

Marine



GL (Germanischer Lloyd) classified
 Environmental category: C, EMC2
 Marine and offshore applications



ABS (American Bureau for Shipping) PDA

EAC TR Registration



Registration for the Eurasian Customs Union market
 (Russia, Kazakhstan, Belarus)

19. ROHS, REACH AND OTHER FULFILLED STANDARDS

RoHS Directive



Directive 2011/65/EU of the European Parliament and the
 Council of June 8th, 2011 on the restriction of the use of
 certain hazardous substances in electrical and electronic
 equipment.

REACH Directive



Directive 1907/2006/EU of the European Parliament and the
 Council of June 1st, 2007 regarding the Registration,
 Evaluation, Authorisation and Restriction of Chemicals
 (REACH)

20. PHYSICAL DIMENSIONS AND WEIGHT

Width	32mm 1.26"
Height	124mm 4.88"
Depth	117mm 4.61"
	The DIN-rail height must be added to the unit depth to calculate the total required installation depth.

Weight	500g / 1.1lb
DIN-Rail	Use 35mm DIN-rails according to EN 60715 or EN 50022 with a height of 7.5 or 15mm.
Housing material	Body: Aluminium alloy Cover: zinc-plated steel
Installation clearances	See chapter 2

Fig. 20-1 **Front view**

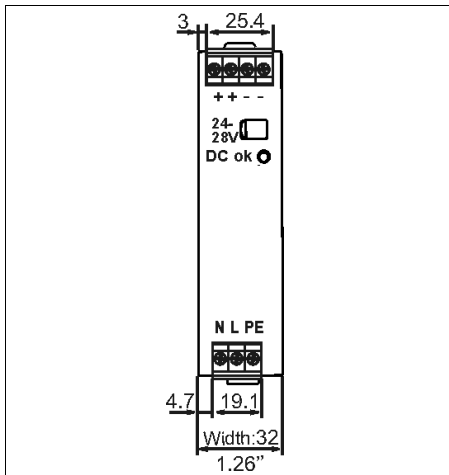
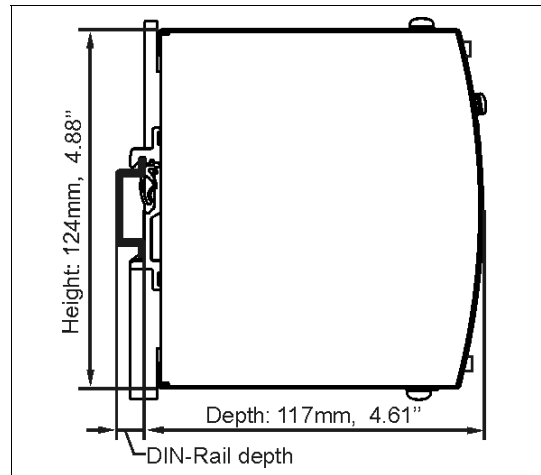

Fig. 20-2 **Side view**



21. ACCESSORIES

21.1. ZM1.WALL - WALL MOUNTING BRACKET

This bracket is used to mount the power supply onto a flat surface without utilizing a DIN-Rail.

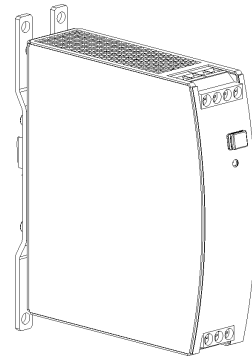
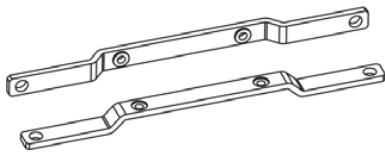

21.2. ZM13.SIDE - SIDE MOUNTING BRACKET

This bracket is used to mount Dimension units sideways with or without utilizing a DIN-Rail. The two aluminum brackets and the black plastic slider of the unit must be detached so that the steel brackets can be installed.

For sideways DIN-rail mounting, the removed aluminum brackets and the black plastic slider need to be mounted on the steel bracket.

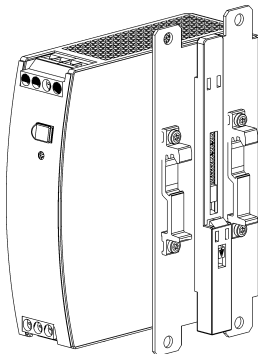

Side mounting with DIN-rail brackets

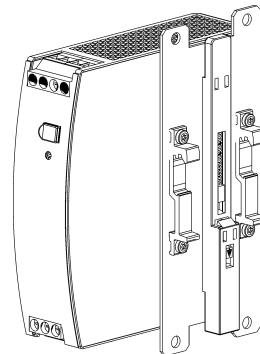

Side mounting without DIN-rail brackets

21.3. REDUNDANCY MODULES

YRM2.DIODE – (2x 10A Inputs, 1x 20A output)



The YRM2.DIODE is a dual redundancy module, which can be used to build redundant systems. It is equipped with two input channels, which are individually decoupled by utilizing diodes.

The YRM2.DIODE does not require an additional auxiliary voltage and is self-powered even in case of a short circuit across the output.

The YRM2.DIODE has a monitoring circuit included and is the perfect solution when the power supply has no DC-OK function. Two LEDs and two relay contacts signal when one of the two DC-input voltages is not in range due to a non-functioning or disconnected power supply.

Due to the compact design, the unit is very slender and only requires 32mm width on the DIN-rail.

Fig. 21-1 **Typical 1+1 Redundant configuration for 5A load current**

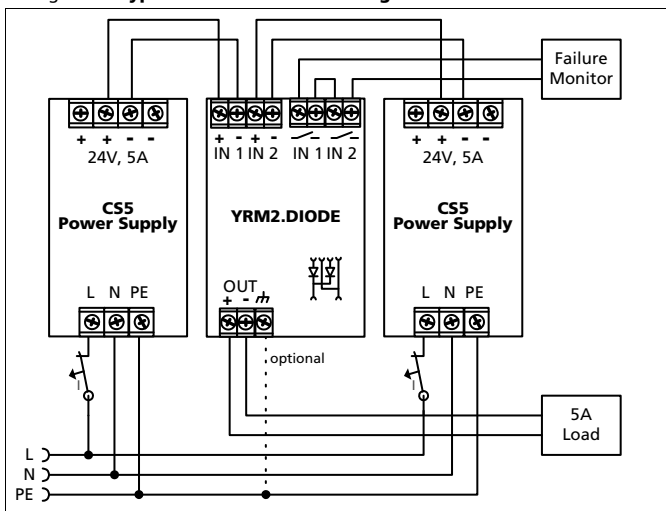

22. APPLICATION NOTES

22.1. PEAK CURRENT CAPABILITY

The unit can deliver peak currents (up to several milliseconds) which are higher than the specified short term currents. This helps to start current demanding loads. Solenoids, contactors and pneumatic modules often have a steady state coil and a pick-up coil. The inrush current demand of the pick-up coil is several times higher than the steady-state current and usually exceeds the nominal output current (including the PowerBoost). The same situation applies when starting a capacitive load.

The peak current capability also ensures the safe operation of subsequent circuit breakers of load circuits. The load branches are often individually protected with circuit breakers or fuses. In case of a short or an overload in one branch circuit, the fuse or circuit breaker need a certain amount of over-current to open in a timely manner. This avoids voltage loss in adjacent circuits.

The extra current (peak current) is supplied by the power converter and the built-in large sized output capacitors of the power supply. The capacitors get discharged during such an event, which causes a voltage dip on the output. The following two examples show typical voltage dips:

Fig. 22-1 **Peak load with 2x the nominal current for 50ms, typ.**

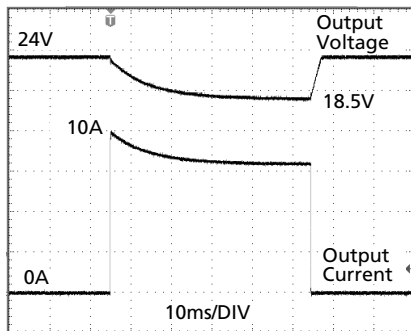

10A Peak load (resistive) for 50ms
Output voltage dips from 24V to 18.5V.

Fig. 22-2 **Peak load with 5x the nominal current for 5ms, typ.**

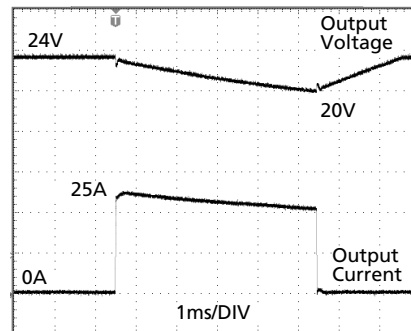

25A Peak load (resistive) for 5ms
Output voltage dips from 24V to 20V.

Peak current voltage dips	typ.	from 24V to 18.5V	at 10A for 50ms, resistive load
	typ.	from 24V to 22V	at 25A for 2ms, resistive load
	typ.	from 24V to 20V	at 25A for 5ms, resistive load

22.2. BACK-FEEDING LOADS

Loads such as decelerating motors and inductors can feed voltage back to the power supply. This feature is also called return voltage immunity or resistance against Back- E.M.F. (Electro Magnetic Force).

This power supply is resistant and does not show malfunctioning when a load feeds back voltage to the power supply. It does not matter whether the power supply is on or off.

The maximum allowed feed-back-voltage is 35Vdc. The absorbing energy can be calculated according to the built-in large sized output capacitor which is specified in chapter 6.

22.3. EXTERNAL INPUT PROTECTION

The unit is tested and approved for branch circuits up to 20A. An external protection is only required if the supplying branch has an ampacity greater than this. Check also local codes and local requirements. In some countries local regulations might apply.

If an external fuse is necessary or utilized, minimum requirements need to be considered to avoid nuisance tripping of the circuit breaker. A minimum value of 16A B- or 10A C-Characteristic breaker should be used.

22.4. PARALLEL USE TO INCREASE OUTPUT POWER

The power supply shall not be used in parallel to increase the output current.

22.5. PARALLEL USE FOR REDUNDANCY

Power supplies can be paralleled for redundancy to gain higher system availability. Redundant systems require a certain amount of extra power to support the load in case one power supply unit fails. The simplest way is to put two power supplies in parallel. This is called a 1+1 redundancy. In case one power supply unit fails, the other one is automatically able to support the load current without any interruption, see also chapter 22.4.

Please note: This simple way to build a redundant system does not cover failures such as an internal short circuit in the secondary side of the power supply. In such a case, the defective unit becomes a load for the other power supplies and the output voltage can no longer be maintained. This can be avoided by utilizing redundancy modules, which have decoupling devices (diodes or MOSFETs) included. Further information and wiring configurations can be found in chapter 21.3.

Recommendations for building redundant power systems:

- a) Use separate input fuses for each power supply.
- b) Monitor the individual power supply units.
Therefore, use the DC-OK relay contact of the YRM2.DIODE.
- c) It is desirable to set the output voltages of all units to the same value ($\pm 100\text{mV}$) or leave it at the factory setting.

22.6. SERIES OPERATION

Power supplies of the same type can be connected in series for higher output voltages. It is possible to connect as many units in series as needed, providing the sum of the output voltage does not exceed 150Vdc. Voltages with a potential above 60Vdc are no longer SELV and can be dangerous. Such voltages must be installed with a protection against touching.

Earthing of the output is required when the sum of the output voltage is above 60Vdc.

Avoid return voltage (e.g. from a decelerating motor or battery) which is applied to the output terminals.

Keep an installation clearance of 15mm (left / right) between two power supplies and avoid installing the power supplies on top of each other. Do not use power supplies in series in mounting orientations other than the standard mounting orientation (input terminals on bottom of the unit).

Pay attention that leakage current, EMI, inrush current, harmonics will increase when using multiple power supplies.

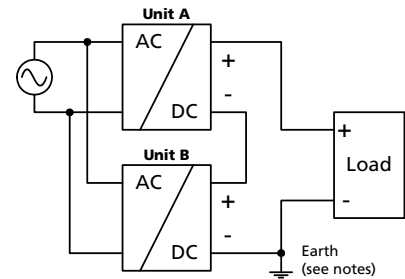

22.7. INDUCTIVE AND CAPACITIVE LOADS

The unit is designed to supply any kind of loads, including capacitive and inductive loads.

22.8. CHARGING OF BATTERIES

The power supply shall not be used to charge batteries. Choose power supplies of the QS-Series for charging batteries.

22.9. OPERATION ON TWO PHASES

The power supply can also be used on two-phases of a three-phase-system. A phase-to-phase connection is allowed as long as the supplying voltage is below 240V^{+10%}.

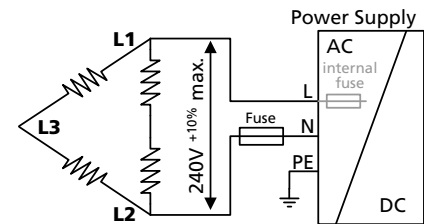

22.10. USE IN A TIGHTLY SEALED ENCLOSURE

When the power supply is installed in a tightly sealed enclosure, the temperature inside the enclosure will be higher than outside. In such situations, the inside temperature defines the ambient temperature for the power supply.

The following measurement results can be used as a reference to estimate the temperature rise inside the enclosure.

The power supply is placed in the middle of the box, no other heat producing items are inside the box

Enclosure:	Rittal Typ IP66 Box PK 9516 100, plastic, 110x180x165mm
Load:	24V, 4A; (=80%) load is placed outside the box
Input:	230Vac
Temperature inside enclosure:	45.8°C (in the middle of the right side of the power supply with a distance of 2cm)
Temperature outside enclosure:	23.0°C
Temperature rise:	22.8K

22.11. MOUNTING ORIENTATIONS

Mounting orientations other than the input terminals on the bottom require a reduction in continuous output power or a limitation in the maximum allowed ambient temperature. The amount of reduction influences the lifetime expectancy of the power supply. Therefore, two different derating curves for continuous operation can be found below:

Curve A1

Recommended output current.

Curve A2

Max allowed output current (results in approximately half the lifetime expectancy of A1).

Fig. 22-3
Mounting Orientation A
(Standard orientation)

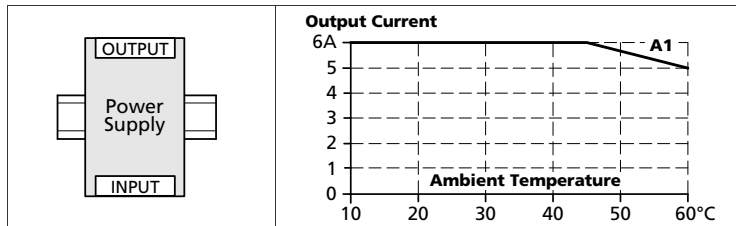

Fig. 22-4
Mounting Orientation B
(Upside down)

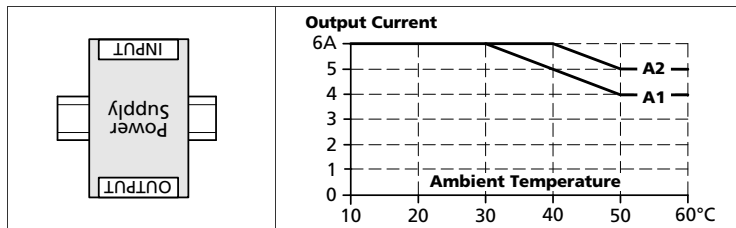

Fig. 22-5
Mounting Orientation C
(Table-top mounting)

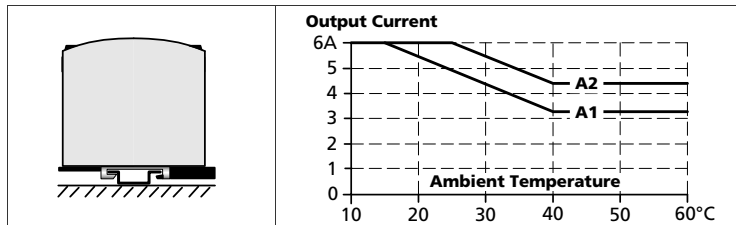

Fig. 22-6
Mounting Orientation D
(Horizontal cw)

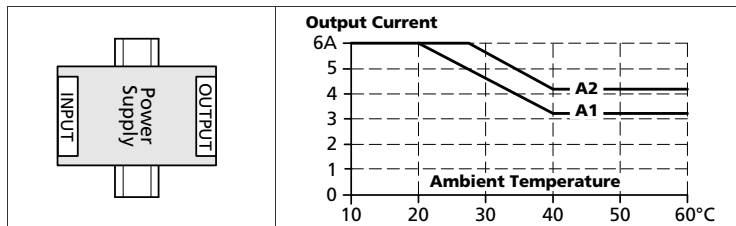

Fig. 22-7
Mounting Orientation E
(Horizontal ccw)

